

# **EMERGENCY PROCEDURE MANUAL**

**IPSWICH  
MULTI SERVICE CENTRE**

**Chermside Road  
Ipswich QLD 4305**

## Contents

Contents .....	2
1.0 INTRODUCTION .....	3
2.0 EMERGENCY CONTACT TELEPHONE NUMBERS .....	3
3.0 DEFINITIONS .....	4
4.0 LOCATION OF THE EMERGENCY PROCEDURES MANUAL .....	7
5.0 EMERGENCY SYSTEMS.....	8
6.0 CLASSIFICATION OF FIRES.....	9
7.0 EVACUATION ASSEMBLY AREAS.....	9
8.0 EMERGENCY CONTROL CENTRE (ECC).....	10
9.0 EMERGENCY EVACUATION PLANS.....	10
10.0 EMERGENCY CONTROL ORGANISATION (ECO) .....	10
11.0 DISASTER MANAGEMENT.....	11
12.0 ACCOMMODATION FOR CLIENTS.....	12
13.0 RELOCATION OF CLIENTS AND STAFF.....	12
14.0 COMMUNICATIONS DURING / FOLLOWING A DISASTER.....	12
15.0 EMERGENCY PROCEDURES.....	15
15.1 CODE RED – FIRE AND SMOKE.....	15
15.2 CODE ORANGE – EVACUATION .....	20
15.3 CODE PURPLE – BOMB THREAT.....	25
15.4 CODE BLACK – PERSONAL THREAT .....	27
15.5 CODE YELLOW – INTERNAL EMERGENCY .....	30
15.6 CODE BROWN – EXTERNAL EMERGENCY .....	31
15.7 CODE BLUE – MEDICAL EMERGENCY / FIRST AID.....	40
15.8 MISSING PERSON.....	42
16.0 REFERENCES.....	45
17.0 ASSOCIATED PROCEDURES AND FORMS.....	45
18.0 APPENDIX A – EMERGENCY CONTROL ORGANISATION REGISTER.....	46
19.0 APPENDIX B EMERGENCY EVACUATION PLANS .....	47

## 1.0 INTRODUCTION

### Purpose of the Manual

This manual contains procedures for handling internal and external emergencies and for the evacuation of sites. The procedures within this manual are developed in accordance with Australian Standards AS 3745-2010 and AS 4083-2010.

### Scope of the Manual

This manual has been developed for the region of West Moreton and Ipswich Multi-Service Centre located at 83- 85 Chermside Road Ipswich, Qld 4305.

### Revision

This manual will be reviewed annually by the Emergency Planning Committee who will ensure that revisions are logged and reproductions of the manual are updated.

A register will be kept by the Emergency Control Organisation (ECO) of the location and number of copies of this manual as per Section 3.0. The Emergency Procedure Manual is document controlled by the Quality Coordinator. See Appendix A for ECO Register

## 2.0 EMERGENCY CONTACT TELEPHONE NUMBERS

<b>Police / Ambulance / Queensland Fire Emergency Services</b> .....	Dial 0 then 000
Aged Care Complaints Investigation for all clients.....	1800 550 552
Bureau of Meteorology (Weather Warning and Forecasts).....	1900 955 360
Department of Transport and Main Roads (Road conditions and closures).....	13 19 40
Electricity and Gas Supplies	
Life threatening situation .....	13 19 62
Non-life threatening situation .....	13 62 62
Ipswich City Council	
Local Disaster Management Group (LDMG).....	3810 6666
Ipswich Hospital.....	3810 1111
Emergency Management Queensland (Other than Storm and Flood) .....	3635 1890
Firevacs (Fire Maintenance) .....	1300 387 387
Poison Information Line .....	13 11 26
State Emergency Service	<a href="http://www.emergency.qld.gov.au">www.emergency.qld.gov.au</a>
(Storm and Flood Damage).....	132 500 or 137 468
Water and Sewerage (Faults and Emergencies).....	13 26 64
Welfare Hotline (Missing persons in a disaster).....	As advertised by the media

## AFTER HOURS CONTACTS

### **Kerri Lanchester**

Community Service Manager .....0448 165 573

### **Belinda Holden**

Client Services Coordinator .....0472 838 335

### **Donna Weis**

Home Care Manager .....0472 832 554

### **Trudie Black**

Case Manager .....0447 050 763

### **Amy Prasad**

Director of Community Services.....0428 739 132

### **Stephen McNally**

Chief Executive Officer .....0417 766 027

### **Simone Watson**

Director of Human Resources .....0412 149 273

### **Elaine Bray**

Clinical Governance and Quality Manager .....0458 012 125

### **Advice Helpline**

24/7 - to assist with extra personnel or contact with CEO.....1800 639 331

## FIRE EDUCATION AND EVACUATION DRILLS

In addition to the WHS Act 2001, BFSR 2008 and AS 3745-2010 and AS 4083-2010, and as required under the Aged Care Standards, all staff members shall undergo annual mandatory Fire Fighting and Evacuation Procedures training. All community staff receive Annual General and First response, evacuation Coordination and participate in an evacuation drill.

Fire Education is provided by Fire Safety Compliance Services as of (2016). For all fire Training enquiries, contact:

### **Cintia Papp**

Fire Safety Advisor.....3422 3006

### **Adam Birgan**

Fire Safety Compliance Services.....0411 023 099

## 3.0 DEFINITIONS

### **Emergency**

An event that arises from internal or external sources which may adversely affect persons or the community generally and which requires an immediate response.

Whenever the internal or external emergency plans are activated, the facility will be considered to be in **EMERGENCY STATUS**, with specific responsibilities assigned to facilitate personnel management and resource allocation.

## Emergency Codes

This manual contains work instructions for dealing with the following emergencies:

<b>CODE RED – FIRE AND SMOKE</b>
When fire or smoke is detected
<b>CODE ORANGE – EVACUATION</b>
Refers to movement of clients, staff, and visitors from the facility in a rapid and safe manner
<b>CODE PURPLE – BOMB THREAT</b>
Refers to a written threat, telephone threat, suspect object or suspect mail
<b>CODE BLACK – PERSONAL THREAT</b>
Armed or unarmed Confrontation where: <ul style="list-style-type: none"><li>• person is suspected to be carrying a weapon/ dangerous article;</li><li>• unarmed person threatens someone with violence;</li><li>• a person threatens suicide; and/or</li><li>• a demand is made for drugs</li></ul>
<b>CODE YELLOW – INTERNAL EMERGENCY</b>
Refer to a failure of vital internal services: gas, electricity and communications, water shortage or contamination of water supply
<b>CODE BROWN – EXTERNAL EMERGENCY</b>
Refer to an emergency occurring outside the facility - caused by aircraft or helicopter crash, major road accident, bridge collapse, civil unrest, bushfires, cyclones, earth quakes, severe storms, heatwave, floods and/or explosions etc
<b>CODE BLUE – MEDICAL EMERGENCY</b>
For all medical/first aid related incidents or emergencies, in the event of a suspected cardiac arrest or the need for urgent medical assistance
<b>OTHER – MISSING PERSON</b>
Emergency occurring on discovery that a client has gone missing from the care provided within the AQ Multi-Service Centre or in their homes, or missing from the care provided by AQ staff during an activity organised by AQ staff outside the AQ Multi-Service Centre or their homes.

### **Emergency Planning Committee (EPC)**

Emergency Planning Committee is the Emergency Management Team and consists of a committee responsible for **establishing an emergency management plan, emergency response procedures and an Emergency Control Organisation (ECO)**.

The Emergency Planning Committee shall be formed from representatives of occupant groups. The membership of the Emergency Planning Committee shall include AQ senior managers, a Chief Warden from a Multi-Service Centre (MSC) and others who may have specialist knowledge.

The EPC shall ensure that, during emergencies, instructions given by ECO personnel shall overrule normal management structure. The purpose of these powers is to ensure that during an emergency situation, life safety takes precedent over asset protection and production matters.

The Emergency Procedures Manual shall be reviewed at least once each year by a committee of appropriately qualified and experienced personnel. The committee shall include, as a minimum, AQ senior managers, a Chief Warden from a Multi-Service Centre (MSC) and others from external agencies who may have specialist knowledge. For example, Brisbane Local Disaster Management Group.

The EPC shall meet at least annually to:

- Establish and implement emergency plans and procedures;
- Determine the number of ECO personnel consistent with the nature and risk of the building, structure and workplace;
- Ensure that the personnel are appointed to all positions on the ECO and replacement personnel are appointed improvements where necessary;
- Arrange for training of the ECO personnel;
- Arrange to conduct evacuation exercises;
- Review the effectiveness of the evacuation exercises and arrange for procedures improvements; and
- Determine who will implement emergency procedures.

### **EPC Members:**

- Community Service Manager (CSM)
- Quality and Clinical Governance Manager
- Fire Safety Adviser
- Multi-Service Centre Chief Warden selected by the EPC

### **Emergency Control Organisation (ECO)**

Emergency Control Organisation is a structured organization that will initiate an appropriate response to emergency situations at the local level. During emergencies instructions given by the Chief Warden (Community Service Manager or delegate) shall overrule normal management structure. The Emergency Control Organisation consists of the Community Service Manager or delegate, a dedicated Communication Officer and the Area Warden who is appointed by the CSM.

### **Emergency Management Plan**

A documented scheme of assigned responsibilities, actions and procedures, required in the event of an emergency.

### **Chief Warden**

The Chief Warden is the Community Service Manager or delegate. The Chief Warden establishes the ECO at the Multi-Service Centre and is appointed by and responsible to the EPC.

Chief Warden is not applicable in client home settings.

### **Area Warden**

The Area Warden is appointed by the Chief Warden and assists the Chief Warden where required and shall assume the responsibilities normally carried out by the Chief Warden if the Chief Warden is unavailable.

Area Warden is not applicable in client home settings.

### **Fire Detection**

The Ipswich Multi Service Centre is fitted with smoke detectors.

### **Fire Safety Adviser**

The Fire safety Adviser will liaise with the Emergency Planning Committee and during an Emergency Status may be required if deemed appropriate to establish and manage the Emergency Control Organisation.

### **Fire Fighting Equipment/ Assistive Devices**

Are designated on the Emergency Evacuation Plans located in each building and consist of:

- Fire Extinguishers (dry powder);
- Fire Blankets; and
- AlbacMat Rescue Mats.

### **Persons with Disabilities**

Persons having physical, intellectual, visual or auditory disabilities or impairments, either temporary or permanent.

## **4.0 LOCATION OF THE EMERGENCY PROCEDURES MANUAL**

The Ipswich Multi-Service Centre has three Emergency Procedures Manual, which is located in the Kitchen of each Multi-Service Centre building.

In addition, an electronic copy is also placed on the intranet of the Association and it is available for all staff.

The revision of the Emergency Procedures Manual is to be conducted by the EPC or delegate annually as per Section 1.3.

Date of Revision	Revision undertaken by	Signature
03/01/2012	Margaret Haffenden	<i>Margaret Haffenden</i>
02/04/2013	Margaret Haffenden	<i>Margaret Haffenden</i>
24/11/2014	Brooke Suess	
22/08/2016	Tracey Deans	<i>Tracey Deans</i>
09/05/2018	Tracey Deans	<i>Tracey Deans</i>
04/07/2019	Michelle Bambridge and Tracey Deans	<i>Tracey Deans</i>
01/07/2020	Michelle Bambridge and Cintia Papp	<i>Papp Cintia</i>
10/02/2021	Cintia Papp	<i>Papp Cintia</i>
05/05/2021	Cintia Papp	<i>Papp Cintia</i>
16/11/2022	Simone Diefenbach, Amy Prasad, Cintia Papp	<i>Papp Cintia</i>
20/12/2023	Belinda Holden, Eden Sleightholme, Cintia Papp	<i>Papp Cintia</i>

## 5.0 EMERGENCY SYSTEMS

### Alarm Systems

On activation of a smoke detector Ipswich Multi-Service Centre staff will be notified of the alarm and will call 000 – for Queensland Fire and Emergency Service. If it is a fault in the system maintenance is to be called. Also the CSM of the Multi-Service Centre, and Chief Executive Officer (CEO) is to be notified of the situation.

### Detection Systems

Smoke Detectors are located throughout the buildings at the Multi-Service Centre. These are designed to detect small particles normally found in smoke but dust can activated these units. When activated a smoke detector will initiate an alarm.

### Suppression Systems

Fire Extinguishers are located in each building at the Multi-Service Centre and are Dry Chemical Powder - DCP extinguishers. The extinguishing method is by smothering and inhibiting the fire. It is used to extinguish Class A, B, (E) and F fires. Dry Chemical Powder extinguishers are red in colour with a white band, water extinguishers are red and carbon dioxide extinguishers are red with black band. The location of the extinguishers is nominated on the Emergency Evacuation Plans located throughout the Multi-Service Centre.



Fire Blanket is located in the kitchen of the Multi-Service Centre.





## Assistive Devices

AlbacMat rescue mats are located in bedroom one on top of linen cupboard of the accommodation building of the Multi-Service Centre.



This device is used to evacuate non-ambulant residents from buildings (see Part 15 - EVACUATION **CODE ORANGE**).

## 6.0 CLASSIFICATION OF FIRES

Fires are classified according to fuel type and presence of electricity. Before using a fire extinguisher, you must know:

- What type of fuel is burning; and
- What type of extinguisher is suitable for the fire.

Fire class and best extinguishing methods are summarised below.

Class & Type of Fire		A	B	C	D	(E)	F
Type of Extinguisher	Colours	Wood, Paper, Plastic	Flammable & Combustible Liquids	Flammable Gases	Combustible Metals	Electrically Energised Equipment	Cooking Oils and Fats
Water		✓	✗	✗	✗	✗	✗
Carbon Dioxide (CO2)		LIMITED	LIMITED	✗	✗	✓	✗
Dry Chemical Powder (ABE/BE)		✓ AB(E)	✓	✓	✗	✓	✗ AB(E)
		✗ B(E)					✓ B(E)
Foam		✓	✓	✗	✗	✗	LIMITED
Wet Chemical		✓	✗	✗	✗	✗	✓

## 7.0 EVACUATION ASSEMBLY AREAS

Ipswich Multi-Service Centre has one evacuation assembly point which is located on the footpath, Cherside Road. The location of the evacuation assembly point is shown on the emergency evacuation plans. See Appendix B.

For clients' homes the mailbox is considered to be the evacuation assembly point. If the mailbox is not a safe location, near the road or further away from the house or immediate danger is applicable.

## 8.0 EMERGENCY CONTROL CENTRE (ECC)

Emergency Control Centre is located in the administration building No. 85 of Ipswich Multi-Service Centre.

## 9.0 EMERGENCY EVACUATION PLANS

Are located in each building of the Ipswich Multi-Service Centre and are enclosed in Appendix B.

Emergency evacuation plans are not applicable for clients' homes.

## 10.0 EMERGENCY CONTROL ORGANISATION (ECO)

Emergency Control Organisation is a structured organization that will initiate an appropriate response to emergency situations.

The ECO comprises of the Chief Warden, Area Warden and the Communications Officer.

ECO is not applicable in client home settings. In case of an emergency, Case Manager / Care Coordinator or delegate will coordinate the emergency situation in conjunction with Home Care Manager.

### ECO Members:

Chief Warden – Community Service Manager (CSM) or delegate

Area Warden – All Staff members of Multi-Service Centre

Dedicated Communication Officer – Multi-Services Centre staff member

### Role and Responsibility of:

**Chief Warden** – The Chief Warden is the most senior staff member on duty and should have a good knowledge of the layout of the building, structure and workplace. The Chief Warden leads the ECO and takes control of the emergency situation.



**Area Warden** - Follows instructions given by the Chief Warden. Area Wardens may also assume the role of the Communications Officer. Area Wardens should be appointed consistent with the level of their day-to-day responsibilities. It is essential that the persons appointed have the qualities needed to enable them to perform duties required in emergencies.



Factors to be considered include the following:

- Availability – they should be persons who spend most of their time at, or near, their workstations;
- Ability to organize others in an emergency; and
- Reliability.

**Communications Officer** – role is delegated by the Chief Warden.

The communications officer shall be competent in the use of the communication equipment within the building and workplace and have a clear commanding voice. The Communications Officer is to

alert the Emergency Services of the emergency. A Communications Officer's duties may be carried out by an Area Warden or Chief Warden.

### **Indemnity**

Both the EPC and ECO personnel shall be indemnified by their employer against civil liability resulting from workplace emergency response assessment, education, training sessions, periodic exercises or emergency evacuation of a building where the personnel act in good faith and in the course of their emergency control duties. (AS 3745-2010).

## **11.0 DISASTER MANAGEMENT**

### **External Disasters**

External disasters are defined as disasters that occur from environmental forces and manmade disasters, which occur external to the Multi-Service Centres operated by the Association. These disasters prevent the continued operation of services provided by the Multi-Service Centres. The disasters are a result of but not confined to:

- Bushfires
- Cyclones
- Earthquakes
- Severe Storms
- Floods
- Airline/Helicopter Crashes
- Explosions
- Landslides
- Major road accident
- Bridge Collapse
- Civil Disorder
- Heatwave

### **Internal Disasters**

Internal disasters are those disasters which damage facilities and services provided for staff and clients of the Association and may cause the capabilities of the facility to be reduced and/or endanger the lives of the occupants of the buildings. Internal disasters are a result of:

- Flooding within the centre
- Fire
- Loss of Communication
- Loss of Power
- Heatwave
- Loss/ Damage to Gas Supply
- Damage to Buildings
- Blocking of exits & entry points
- Contamination of water supply
- Hazardous Material Spill
- Sewage Disruption

The Association will follow regular updates through the Ipswich City Council website, Ipswich City Council Facebook page, radio announcements from ABC612 or River 949FM and twitter feeds and the Queensland Government <http://www.qldalert.com/> during and emergency event. All managers and Allied Health staff are provided with a smart phone to keep update through these means.

In addition, the Association maintains a SMS system and an email distribution list which are considered the main communication channels with staff in case of internal or external disasters listed above.

For those clients who have been identified as being geographically isolated, living in high risk areas or individual and carers have impairments that would impact on them during and an emergency; this will be considered when developing their care plan to ensure processes are put in place.

## **12.0 ACCOMMODATION FOR CLIENTS**

It is the responsibility of the Association in conjunction with family members to find alternate accommodation for client's arising from an external or internal disaster, which results in the facilities or services occupied by such persons being compromised. Clients/families are provided with resources to assist with developing these emergency plans and sent annual reminders on planning for an emergency. The Association will assist with providing clients, with clinical care, food and water throughout the duration of the emergency event.

Alternate accommodation sought during internal and external disasters may consist transporting clients to their NOK or the use of the Associations neighbouring residential or respite facilities, private or public hospitals, privately operated residential facilities or accommodation prescribed under the direction of the Local District Co-ordination Centre. If there is no alternative means of accommodation, people may initially be accommodated in an evacuation centre.

AQ will utilise the Brisbane Metropolitan Transport Management Centre 13 19 40 hotline and internet page (<http://131940.qld.gov.au/>) to determine safest ways to transport clients throughout the region. As a final resort the Department of Health will be contacted to request assistance via the Ipswich City Council Disaster Management Group (LDMG) or Local Disaster Coordination Centre (LDCC) via the Council Contact Centre on (07) 3810 6666, who will escalate the request through the request for assistance process.

## **13.0 RELOCATION OF CLIENTS AND STAFF**

Emergency Services will be notified about the Multi Service Centre's internal disaster and the need to relocate clients and staff. This notification is to be undertaken by the Community Services Manager (CSM) after consultation with the Director of Community Services. Linkage with other AAQ facilities, NOK or returning to their own home with in home support if required.

Following an external disaster where the carer of a client can't bring a client to a Multi-Service Centre, the centre will attempt to get staff to the client if required and safe to do so. If the client is in need of support and The Associations staff are unable to get to their home the CSM will notify the Ipswich City Council Emergency Line on 3810 666 (District Emergency Responses Officer) of the need for support.

Evacuation Centre's are located in Ipswich and are advertised on the Ipswich City Council Facebook at the time of disaster.

Alzheimer's Queensland Inc. accepts that it has a duty of care to all staff, clients and visitors to the Associations services, and that all staff, clients and visitors have a legal duty of care to each other.

## **14.0 COMMUNICATIONS DURING / FOLLOWING A DISASTER**

The Community Services Manager will notify the Director of Community Services of the extent of the damage to the Multi-Service Centre or the ramifications to service provision created by an internal

or external emergency. Prioritisation of staff and clients will be determined based on the type of event and location. At the direction of the Director of Community Services in conjunction with the CEO, it will be ascertained if the Multi-Service Centre will be able to operate. The CSM will direct staff to notify clients and their carers of the closure of the Multi-Service Centre and discuss support options. All parties will be kept up to date as required and where appropriate individual client plans will be enacted.

During and/or following an external disaster, staff will be required to notify the CSM/Case Manager/Care Coordinator of their availability to work. During or following an external disaster it is also a requirement that the CSM/Case Manager/Care Coordinator is to contact all carers and clients or NOK to determine if they are safe and well. If after several attempts to contact the carers and clients fails, organise for family member to check in on them. If that is not an option, contact the Police and SES and report them as not accounted for.

After a disaster, some people may be at increased risk of psychological problems. Recommend that they have a review with their GP or provide options of additional support through:

- [www.lifeline.org.au](http://www.lifeline.org.au)
- [www.grief.org.au](http://www.grief.org.au)
- [www.psid.org.au/public](http://www.psid.org.au/public)

**COMMUNICATION PROCESS FOR EXTERNAL AND INTERNAL PROCESSES**

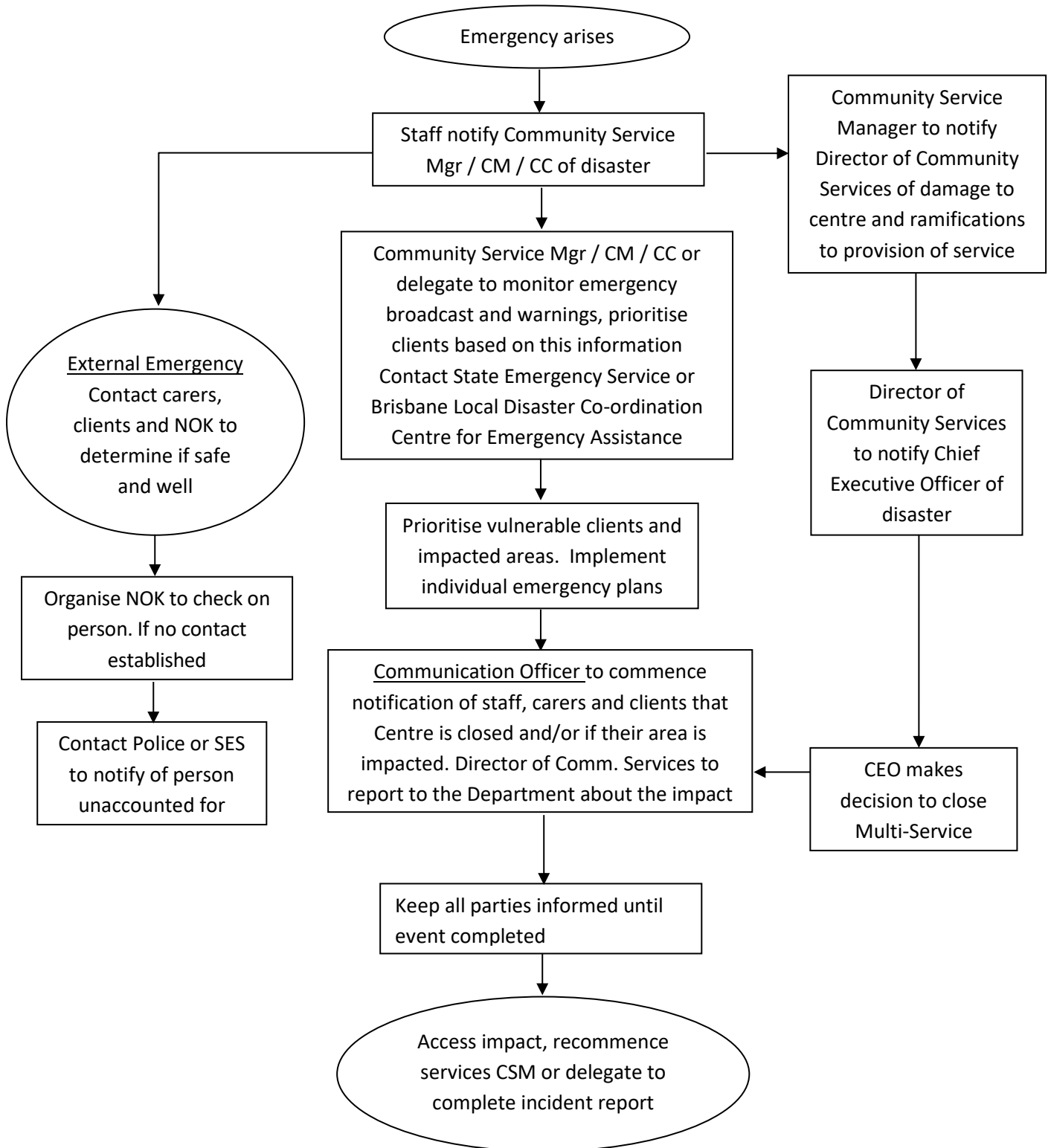

## 15.0 EMERGENCY PROCEDURES

### 15.1 CODE RED – FIRE AND SMOKE

#### **ON FINDING A FIRE OR SMOKE**

Remain calm & remember <b>R A C E</b>	
Remain calm & remember <b>R A C E</b>	
<b>R</b>	<b>Remove</b> people from immediate danger – if safe to do so.
<b>A</b>	<b>Activate Alarm</b> <ul style="list-style-type: none"><li>• Notify the Chief Warden of the type, size and location of the fire.</li><li>• Notify staff in the immediate area of the fire. Maintain Communication with staff members when systematically checking rooms.</li><li>• <b>Alert the Fire Brigade - Call 0 (if applicable) then 000</b></li><li>• Stating address, number of staff working and total number of clients and number of non-ambulant clients</li></ul>
<b>C</b>	<b>Contain</b> fire & smoke Close all doors and windows, turn off gas and extinguish if safe to do so.
<b>E</b>	<b>Evacuate</b> Evacuate the premises via the nearest safe exit to an external assembly point. Co-ordinate evacuation from Stage One to Stage Three if instructed by the Chief Warden.

The **order** in which these actions are performed will depend upon the particular fire incident.

#### **ON HEARING THE FIRE ALARM**

1. **All staff** check your immediate area for the presence of fire before heading to the ECC.
2. Systematically check each room, close windows and doors and place an item such as a pillow in front of the door and visually check the verandas for the presence of a fire.
3. Wait for instructions from the Chief Warden at the emergency control point.
4. If instructed by Chief Warden commence stages one to three of evacuation sequence (See evacuation **CODE ORANGE**).

#### **ROLE OF THE CHIEF WARDEN**

- To take charge of the situation;
- Establish the Emergency Control Organisation (ECO);
- Announce **CODE RED** Fire;
- Designate the role of Area Warden to one staff member;
- Designate the role of Communications Officer to one staff member who is to contact the QFES;
- Instruct the assembled Emergency Control Organisation as to the roles that they are to take when searching for the fire;

- Initiate the evacuation response;
- Wait for the QFES at the Assembly Point and conduct head count;
- Brief the emergency services on arrival on the nature, extent, type and location of the fire; and
- Collect client list/activities list/staff list for roll call at assembly point.

**Alert Community Service Manager/Case Manager/Care Coordinator of Emergency**

**Complete an Incident Report immediately after the event**

**USING FIRE EXTINGUISHER**

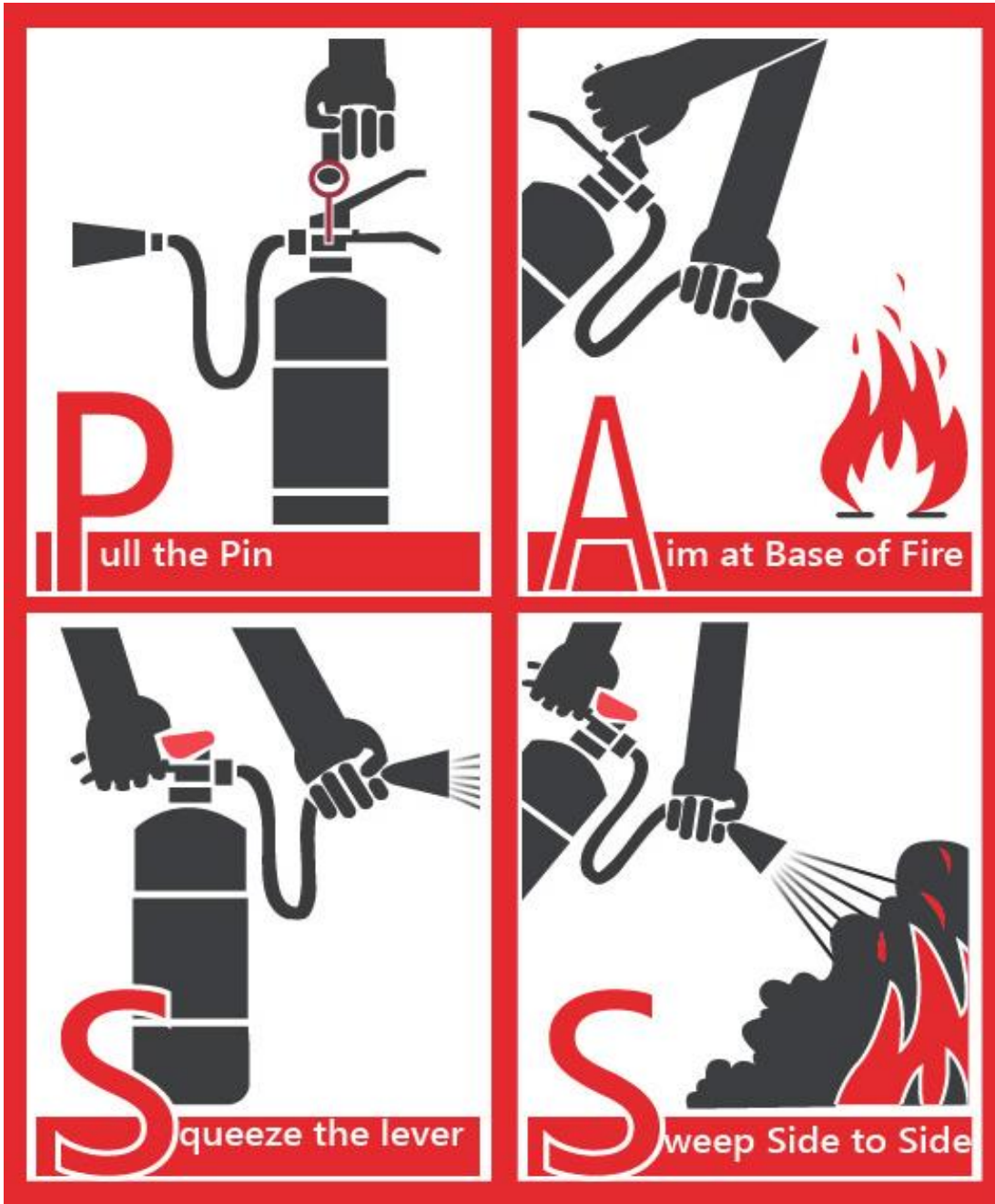



## CODE RED - EMERGENCY RESPONSE GUIDE

R  
A  
C  
E

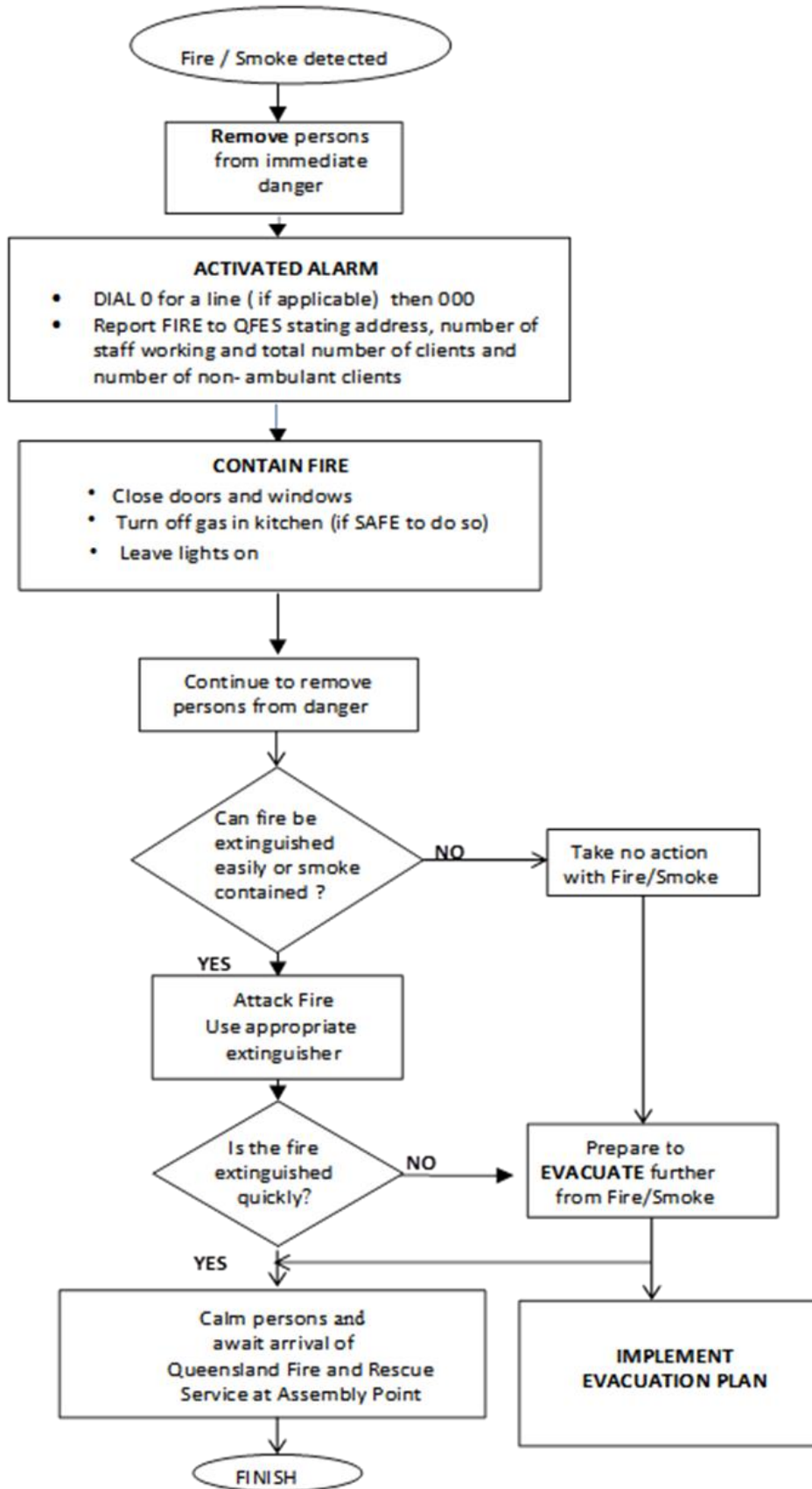

1. **NOTIFY:** Community Service Manager and Director of Home and Community Services about Disaster
2. State Manager to notify CEO
3. Community Service Manager to notify clients carers or family members about disaster
4. Complete incident report

## **FIRE SCENE PRESERVATION**

During the aftermath of any fire, there will always be some form of investigation. Every structural fire which results in some kind of structural damage will require a police report that is forwarded to the Coroner's Office.



The fire brigade attending an incident will assume the role of securing the scene until an investigation can be undertaken or until the attendance of the Queensland Police Service (QPS). However, if the fire is extinguished prior to the arrival of the fire brigade, it is the Chief Warden's responsibility to ensure the fire scene is secured and that the evidence is not disturbed or contaminated.

Preservation of the scene can be defined as the application or use of measures to prevent accidental or deliberate damage, change, alteration or deterioration to the incident site.

If the scene is not preserved and evidence contaminated, it may result in a totally incorrect conclusion to the investigation. More importantly, it may result in evidence being ruled inadmissible during court proceedings against a person charged with a criminal offence.

In addition, to the contamination of physical evidence, the preservation of the fire scene should be undertaken for the safety and welfare of residents and staff. Parts of the building or suspended ceilings can collapse and the atmosphere in and around the incident will contain toxic gases.

The Chief Warden should ensure that the immediate area is evacuated and all electrical equipment is left in its original position. If a master switch is turned off for the safety of personnel, it is imperative that this is reported to the fire brigade as soon as possible.

### **PHYSICAL EVIDENCE MUST NOT BE TOUCHED.**

If there is a requirement to touch some physical evidence (such as removal of equipment for the rescue of a person), this fact must be reported to the investigators as soon as possible.

**FIRE INVESTIGATIONS** Service (QFES) will usually be the lead investigative agency after a fire incident. Generally the QPS and QFES will work as a team but the details of the incident will dictate which agency leads the investigation. The QPS will lead investigations on incendiary fires and the fire brigade will lead investigations on accidental fires.

The two basic scenarios where police will investigate fires are:

- Fires where a suspicion of arson exists;
- Fires involving death or serious injury.

The QFES will concentrate on accidental fires determining:

- Unsafe appliances
- Unsafe work practices
- Unsafe building practices

Note: As soon as the QFES determines that there is some criminal involvement in the fire, the investigation is passed back immediately to the QPS.

Although the lead investigative agencies will be either QPS or the QFES, there will be numerous investigations being carried out by other organisations at a major fire in a health facility. These organisations are permitted by law to conduct their own investigation whilst abiding by protocols and procedures of investigations. Investigative organisations additional to the QPS and the QFES may include:

- Department of Industrial Relations (Electrical and Gas Examiner)
- Department of Health officials
- Workplace Health and Safety Representatives
- Department of Fair Trading (to recall faulty electrical equipment)
- Private legal investigators
- Insurance loss adjusters
- Media
- Coroner (will only attend the scene for major incidents)

## 15.2 CODE ORANGE – EVACUATION

Refers to movement of clients, staff and visitors from the Multi–Service Centre in a rapid and safe manner. This could be as a result of Fire, Smoke, Internal Emergency, External Emergency, Bomb Threat or Personal Threat. For the Multi Service Centre, if there is time to do so the Emergency Kit should be taken when evacuating (refer to Emergency Kit Contents Form RES 069).

### **REMAIN CALM DO NOT RUN OR SHOUT**

**ALERT: Queensland Fire and Emergency Service, state location and nature of problem.** Call 0 (if applicable) then 000

### **ON INSTRUCTION FROM CHIEF WARDEN**

**Stage 1: Remove Persons from immediate Danger Area**

**Stage 2: Complete Evacuation of the entire Complex**

- Check all rooms close doors behind you and mark with an indicator to indicate that the area has been checked and is all clear (place pillow in front bedroom doors);
- Evacuate Ambulant Persons first;
- Semi-ambulant persons next; and
- Non-Ambulant persons last.

**Stage 3: Roll Call**

- Once evacuated to Assembly Point conduct a Head Count. Report any missing persons to Chief Warden

**Stage 4: Organise Pick up or Drop off of Clients**

- Those that can return home should go home. Ensure to mark off clients that are unable to return home that night will be transferred to another AAQ facility or NOK.

### **REFER TO ACTIVITY CONTINUITY PLAN**

### **DO NOT RE ENTER THE BUILDING**

**Alert Community Service Manager/Case Manager/Care Coordinator & Director of Community Services of Emergency.**

**Complete an Incident Report immediately after the event**

When evacuating clients from the Ipswich Multi-Service Centre or their homes, make sure that you **give client's clear and easy to understand instructions on how the evacuation will take place and where the assembly point is located.**

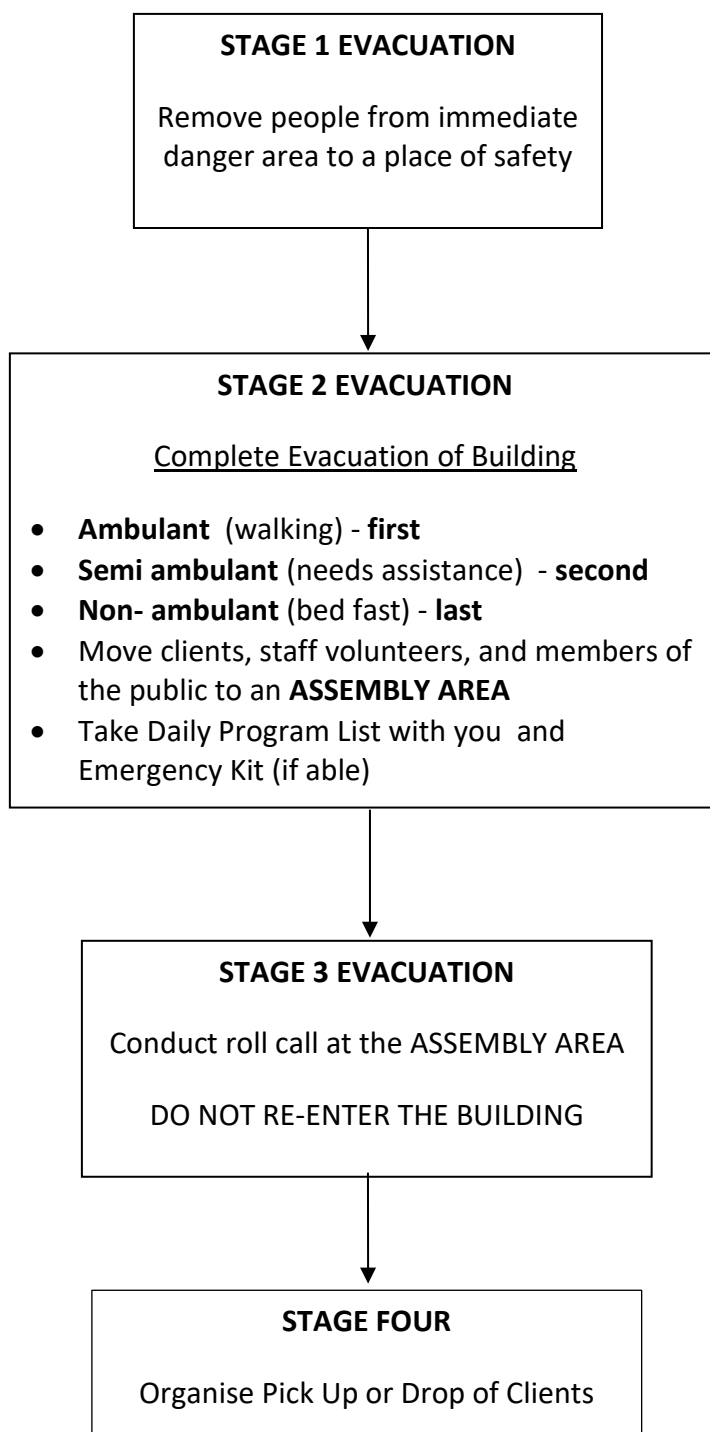

## EVACUATION METHODS

### Using the AlbacMat™ Rescue Mat – **not applicable in client's homes**

#### About the Mat

To use the AlbacMat™ hold the AlbacMat™ by the top handle in front of you with the logo facing outwards. Stand at the foot end of the bed and 'throw out' the AlbacMat™ to unravel it (keep hold of the handle) beside the bed. Once unravelled, ensure the client is lying on their side and position the mat close to the length of the client.

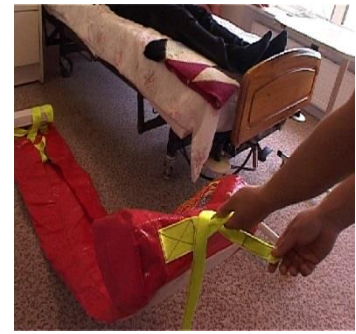

*Unrolling the AlbacMat™ for use*

With the client on their side, roll the client back once more so that they are now on the AlbacMat™.

#### Evacuation

Release the straps on each side of the mat, strap the client in across the chest and the knee area. Use the side strap at the head end of the AlbacMat™ to turn the client and lower them from the bed to pull them to safety. If the client is on the floor in a narrow area, use the handle (not the strap) at the foot end to pull the person to where you can then use the handles at the head end for your comfort.



*Lowering the client from the bed to the floor*

Once the client is at the assembly point, they can be left on the AlbacMat™ while the rescuer returns to evacuate other clients.

An additional method is to undo the mat and place near the feet of the client. Move to the shoulders of the client and roll them away from the AlbacMat™ onto their side. Keeping hold of their shoulder, use the other hand to unroll the AlbacMat™ beside their back. Roll them onto their back and continue. Alternately lower the bed, unravel the AlbacMat™ position the AlbacMat™ beside the client on the floor and lower the resident from the bed directly onto the AlbacMat™.

#### Two Person Rescue

This method may be required with a large or difficult to handle clients.

The process is the same, just with two people working either side of the client. They each have a free hand to assist another person at the same time, such as opening doors should it be required.



*Two people can evacuate a client with ease.*

#### Stairs

The AlbacMat has been tested using various methods of descending stairs and staircases. While it is preferable to have two 'rescuers' when negotiating stairs, it can also be performed by a single person. The two methods are almost opposite in their application. List the recommended procedures for each method below.

Going up stairs can be achieved with one or two people. Individual rescuers abilities, length of stairs and client weight and co-cooperativeness will determine people required.

There is only one method and that is to go straight up! Use the handles at the head end and try to have clients torso raised. This will assist both the rescuers and client's comfort. Caution will need to be exercised as the bottom of the client may fall into each step – although if torso is raised – this is minimised.



### **Single Person Stair Manoeuvre**

It is recommended that the side handles be used for maximum control. The rescuer has brought the client to the staircase and may need to adjust their handle usage before beginning the descent. The rescuer walks on a backward angle down the stairs so that the client will travel backwards down the stairs.

Be aware that the clients' bottom and feet will fall into each step this way so some caution will need to be taken. The residents back may rest against the rescuers thigh. This will assist with balance and gravity for the rescuer as they can almost push into this weight as opposed to being pushed down the stairs. The above method enables the rescuer to have full control of the client and they can turn them as necessary to negotiate each flight of stairs.

### **Two Person Stair Manoeuvre**

The person at the head end is to guide the residents' weight. The AlbacMat will do the work. They need to walk down the stairs almost normally. One of the longer straps may be useful here. The method is to allow the mat to 'skate' over the top of each step, so the lower the client is on the mat, the better weight transference and the easier it will slide down the stairs.

The evacuation involving stairs can be performed a lot quicker with two people. If one person is stationed at the stairs during the evacuation, the staircases will not be a problem.

The rescuer brings the resident on the AlbacMat to the top of the staircase. The resident's feet need to be over the edge of the stairs so the person on the stairs can assist using the handle (not the strap) at the foot pocket in positioning the client. This person then guides the resident until their feet/body are resting on top of the stairs.



The person at the foot end is there as a support and can slow the resident if it gets a little fast. This is done simply by raising the feet, using the handle on the foot pocket. They also turn the resident around the staircase to the next flight. They are also available to 'tug' the mat if required if it stalls on the edge of a step (crease in board may rest upon a step).

This is by far the quicker method (and more comfortable for the client) but it does require two people, which in some cases may not be available.

### **Blanket Removal**

- Spread a blanket (from the bed) on the floor beside and slightly (300mm) under the bed
- Position the resident close to the edge of the bed on the side on which the blanket is spread
- Kneel on the blanket, in line with the resident's head
- Adopt a stable position, with the knee nearest the bed head raised (to protect the resident's
- head while being lowered to the floor)
- Place one arm under the resident's shoulders; pass the other arm across the resident's chest,



- gripping the resident's clothing at the hip
- Gently roll the resident toward you
- Break the resident's fall by cradling the resident against your body
- Support the resident's head with your raised knee
- Gently lower the resident to the blanket
- Fold the resident's arms across his/her chest
- Move to the end of the blanket supporting the resident's head
- Face the resident
- Place each hand a comfortable distance either side of the resident's head and grasp the edge of the blanket
- Raise the resident's head from the floor and drag the resident, head first, to safety
- One-Person Human Crutch



This method is used to support a conscious resident who is able to walk with assistance. Coordinate your steps with the victim to give a broad base of support.

- The rescuer stands on the injured side of the resident
- The resident places arm nearest the rescuer around the rescuer's shoulders
- The rescuer grasps the wrist of the resident with one hand
- With the other hand, the rescuer takes a firm grip of the resident's clothes at the waist on the far side of the body



## 15.3 CODE PURPLE – BOMB THREAT

Refers to a written threat, telephone threat, suspect object or suspect mail/e-mail.

**Call 0 (if applicable) then 000 Police**

**If you receive a bomb threat:**

**REMAIN CALM** Treat call as genuine. Record the exact information on the Bomb Threat Checklist. Do not transfer the call. Prolong the conversation, keep the caller on the line as long as possible.

**DO NOT hang-up.**

### **ATTRACT ATTENTION OF SECOND PERSON**

Do not alert caller to your actions.

Get second person to call 0 (if applicable) then 000 Police & report the call.

**BE ATTENTIVE** Note distinguishing background noises, music, and traffic.

Note voice characteristics/accents.

Does caller indicate knowledge of the building?

**RECORD** Details immediately (Bomb Threat Checklist)

**NOTIFY** The Community Service Manager/Case Manager/Care Coordinator

The Director of Community Services

The Advice Helpline

**PREPARE** To follow instructions of police and other emergency service personnel

To evacuate if necessary

To assist in search if requested

**IF OBJECT FOUND** **Do not touch it.**

Report that you have found it. Open doors and windows where possible and evacuate area to an assembly area well away from possible impact of blast.

## BOMB THREAT CHECKLIST

<b>Exact word of threat:</b>					
<b>Sex:</b>	<input type="checkbox"/> Male	<input type="checkbox"/> Female	<b>Did you recognise the voice?</b>	<input type="checkbox"/> Yes <input type="checkbox"/> No	
<b>Was the caller familiar with the building / area?</b>			<input type="checkbox"/> Yes <input type="checkbox"/> No		
<b>Questions to ask:</b> When is the bomb going to explode? Where did you put the bomb? When did you put it there? What will make the bomb explode? Why did you place the bomb? What is your name?		<b>Threat Language</b>			
		Well spoken	<input type="checkbox"/> Yes	<input type="checkbox"/> No	
		Incoherent	<input type="checkbox"/> Yes	<input type="checkbox"/> No	
		Taped	<input type="checkbox"/> Yes	<input type="checkbox"/> No	
		Message read by caller	<input type="checkbox"/> Yes	<input type="checkbox"/> No	
		Abusive	<input type="checkbox"/> Yes	<input type="checkbox"/> No	
		<input type="checkbox"/> Other:			
<b>Accent:</b>	<input type="checkbox"/> Asian	<input type="checkbox"/> American	<input type="checkbox"/> English	<input type="checkbox"/> Australian	
	<input type="checkbox"/> European	<input type="checkbox"/> Arabic	<input type="checkbox"/> Other:		
<b>Voice:</b>	<input type="checkbox"/> Loud	<input type="checkbox"/> Soft	<input type="checkbox"/> Other:		
<b>Speech:</b>	<input type="checkbox"/> Loud	<input type="checkbox"/> Soft	<input type="checkbox"/> Other:		
<b>Impediment:</b>	<input type="checkbox"/> Lisp	<input type="checkbox"/> Stutter	<input type="checkbox"/> Other:		
<b>Manner:</b>	<input type="checkbox"/> Calm	<input type="checkbox"/> Emotional	<input type="checkbox"/> Other:		
<b>Background Noises:</b>	<input type="checkbox"/> Local call	<input type="checkbox"/> STD call	<input type="checkbox"/> Music	<input type="checkbox"/> Voices	
	<input type="checkbox"/> Street noises	<input type="checkbox"/> Aircraft	<input type="checkbox"/> House noises	<input type="checkbox"/> Machinery	
	<input type="checkbox"/> Other / additional information:				
<b>Call Taken</b>	Time:	Date:	Duration:		
	Number called:				
<b>Threat relating to chemical, biological or radiation</b> What kind of substance is it? How much is in it? How will the substance be released? In what form is the substance (liquid, gas or powder)?		<b>Call Recipient</b>			
		<b>Name:</b>			
		<b>Phone number:</b>			
		<b>Signature</b>			

**Alert Community Service Manager/Case Manager/Care Coordinator & Director of Community Services of Emergency**

**Complete an Incident Report immediately after the Bomb Threat Incident**

## 15.4 CODE BLACK – PERSONAL THREAT

### **ACTIONS TO BE TAKEN WHEN CONFRONTED IN AN ARMED OR UNARMED EVENT:**

- Do not panic - remain calm.
- Obey the offender's instructions but do only what is demanded from them.
- Do not offer information.
- Do not stare at offender.
- Notify Police at first chance by calling 0 (if applicable) then 000.
- Do not go to the aid of a victim during confrontation.
- Do not take risks. Do not play hero.
- Lock all doors and windows after offenders have left.
- Note any distinguishing marks on the perpetrator.
- Take notice of perpetrators voice (accent, impediment, drunk, slang).
- Take notice of perpetrators type and colour of vehicle, registration number and direction of escape.
- Keep all persons away from area to protect the physical evidence.

### **COMPLETE CODE BLACK - OFFENDER CHECKLIST**

**Alert Community Service Manager/Case Manager/Care Coordinator & Director of Community Services of Emergency.**

**Complete an Incident Report immediately after the incident**

**PERSONAL THREAT CHECKLIST**

**DESCRIPTION OF OFFENDER**

Separate Forms are required for each offender. This form is to be complied immediately after the incident by each staff member witnessing the event and also by bystanders.

<b>Name of Witness:</b>								
<b>Occupation:</b>								
<b>Facility:</b>								
<b>Signature:</b>					<b>Date:</b>			
<b>Number of Offenders:</b> <input type="checkbox"/> 1 <input type="checkbox"/> 2 <input type="checkbox"/> 3 <input type="checkbox"/> 4 <input type="checkbox"/> 5					<b>Sex:</b> <input type="checkbox"/> Male <input type="checkbox"/> Female			
<b>Ethnic Origin</b>	<input type="checkbox"/> Caucasian		<input type="checkbox"/> Asian		<input type="checkbox"/> European		<input type="checkbox"/> Aboriginal	
	<input type="checkbox"/> Indian		<input type="checkbox"/> Negro		<input type="checkbox"/> Polynesian		<input type="checkbox"/> Middle Eastern	
<b>Approximate Age:</b>			<b>Height (cm):</b>			<b>Weight (kg):</b>		
<b>Build:</b>	<input type="checkbox"/> Thin	<input type="checkbox"/> Slim	<input type="checkbox"/> Medium	<input type="checkbox"/> Heavy	<input type="checkbox"/> Stout	<input type="checkbox"/> Muscular	<input type="checkbox"/> Fat	
<b>Posture:</b>	<input type="checkbox"/> Erect		<input type="checkbox"/> Stooped			<input type="checkbox"/> Slouchy		
<b>Complexion</b>	<input type="checkbox"/> Fair		<input type="checkbox"/> Olive		<input type="checkbox"/> Acne			
	<input type="checkbox"/> Dark		<input type="checkbox"/> Ruddy		<input type="checkbox"/> Freckled			
	<input type="checkbox"/> Pale		<input type="checkbox"/> Tanned		<input type="checkbox"/> Scarred			
	<input type="checkbox"/> Medium		<input type="checkbox"/> Black		<input type="checkbox"/> Fresh			
<b>Hair:</b>	<b>Colour:</b>				<b>Length:</b>			
	<input type="checkbox"/> Straight	<input type="checkbox"/> Wavy		<input type="checkbox"/> Bald		<input type="checkbox"/> Curly	<input type="checkbox"/> Thick	
<b>Eyes:</b>	<b>Colour:</b>				<b>Size:</b>			
<b>Nose:</b>	<b>Size:</b>				<b>Shape:</b>			
<b>Lips:</b>	<b>Size:</b>				<b>Shape:</b>			
<b>Teeth:</b>	<input type="checkbox"/> Good		<input type="checkbox"/> Spaced			<input type="checkbox"/> Bad		
	<input type="checkbox"/> Uneven		<input type="checkbox"/> Missing		<input type="checkbox"/> Protruding			
<b>Facial Hair:</b>	<input type="checkbox"/> Moustache		<input type="checkbox"/> Stubble		<input type="checkbox"/> Goatee			
	<input type="checkbox"/> Beard		<input type="checkbox"/> Sideburns		<input type="checkbox"/> Full beard			
	<b>Colour:</b>							
<b>Hands:</b>	<input type="checkbox"/> Calloused	<input type="checkbox"/> Soft	<input type="checkbox"/> Hairy		<input type="checkbox"/> Nails / Fingers missing / deformed:			
	<input type="checkbox"/> Large	<input type="checkbox"/> Medium	<input type="checkbox"/> Small	<input type="checkbox"/> Other:				
<b>Glasses:</b>	<input type="checkbox"/> Prescription		<input type="checkbox"/> Tinted Lens		<input type="checkbox"/> Rimless			
	<input type="checkbox"/> Sunglasses		<input type="checkbox"/> Thick Lens		<input type="checkbox"/> Wire Frame			
	<input type="checkbox"/> Plastic	<b>Colour and description of frame:</b>						
<b>Accent:</b>	<input type="checkbox"/> American		<input type="checkbox"/> English		<input type="checkbox"/> European			
	<input type="checkbox"/> Asian		<input type="checkbox"/> Australian		<input type="checkbox"/> Arabic			
	<input type="checkbox"/> Other:							
<b>Voice:</b>	<input type="checkbox"/> Loud	<input type="checkbox"/> Soft		<input type="checkbox"/> Other:				

<b>Impediment</b>	<input type="checkbox"/> Lisp	<input type="checkbox"/> Stutter	<input type="checkbox"/> Other:		
<b>Speech Manner</b>	<input type="checkbox"/> Calm	<input type="checkbox"/> Emotional	<input type="checkbox"/> Other:		
What did the offender do, say, touch, carry etc:					
<b>Scars / marks or jewellery</b>	<input type="checkbox"/> Tattoos	<input type="checkbox"/> Scars	<input type="checkbox"/> Describe location and features:		
	<input type="checkbox"/> Discolouration				
<b>DISGUISES:</b>					
<b>Clothing:</b>	<input type="checkbox"/> Hat	<input type="checkbox"/> Coat	<input type="checkbox"/> Skirt		
	<input type="checkbox"/> Beanie	<input type="checkbox"/> Trousers	<input type="checkbox"/> Sweater		
	<input type="checkbox"/> Balaclava	<input type="checkbox"/> Jeans	<input type="checkbox"/> Shoes		
	<input type="checkbox"/> Shirt	<input type="checkbox"/> Dress	<input type="checkbox"/> Other		
	Type:				
	Colour:			Specific:	
<b>Face</b>	<input type="checkbox"/> Make up	<input type="checkbox"/> Mask	<input type="checkbox"/> Sunglasses		
	<input type="checkbox"/> Stocking	<input type="checkbox"/> Balaclava	<input type="checkbox"/> Handkerchief		
	Type:				
	Colour:			Specific:	
<b>Gloves:</b>	Colour:			Specific:	
<b>WEAPON TYPE:</b>					
<b>Handgun</b>	<input type="checkbox"/> Long / short barrel	<input type="checkbox"/> Revolver / automatic	Specific details:		
<b>Rifle:</b>	<input type="checkbox"/> Barrel – sawn-off	<input type="checkbox"/> Barrel - Full-length	<input type="checkbox"/> Magazine	<input type="checkbox"/> Bolt / auto . pump lever action	
	<input type="checkbox"/> Telescopic sight	Specific details:			
<b>Shotgun:</b>	<input type="checkbox"/> Automatic	<input type="checkbox"/> Pump	<input type="checkbox"/> Double	<input type="checkbox"/> Single	
	<input type="checkbox"/> Barrel – sawn-off	<input type="checkbox"/> Barrel - Full-length	Specific details:		
<b>Wood / knife / metal bar / other:</b>		Specific details:			
<b>Method and direction to escape:</b>					
<b>Make of Car:</b>		<b>Model of Car:</b>		<b>Registration:</b>	
<b>Colour:</b>		<b>No. of vehicles used:</b>		<b>Other details:</b>	

**FAILURE OF VITAL SERVICES - LOSS OR DAMAGE**

- Electricity/Gas
- Water
- Communications

**THREAT TO VITAL INTERNAL SERVICES, STAFF, CLIENTS AND VISITORS BY**

- Flooding within the Multi- Service Centre
- Hazardous Material Spill
- Structural Damage – Damage to buildings
- Illegal Occupancy
- Blocking of exits and entry points
- Contamination of water supply
- Fire
- Heatwave (See Appendix C)
- Sewage Disruption

**Stage 1:**        **Remove persons** from immediate danger

**Stage2:**        **Announce Alarm Dial 0** (if applicable) then **000**

- Exact Location of Internal Emergency
- Type of Internal Emergency
- Notify Relevant Authority associated with failure of Vital Service

**Stage 3:**        **Evacuate** if necessary

**Stage 4:**        **Conduct Roll call** at Assembly Area

**Stage 5:**        **Relocate clients to alternative centres or organise to return home** - Use alternative AAQ facilities if disruption continues beyond 24 hours.

If unable to continue delivery services as per obligations under the agreed agreement to contact The Department.

**Alert Community Service Manager/Case Manager/Care Coordinator & Director of Community Services of Emergency.**

**Complete an Incident Report immediately after the incident**

**Emergency occurring outside the facility (External Disaster) which impacts upon the sustainability of the service offered to clients and carers from the Multi-Service Centre. External Disaster is caused by aircraft or helicopter crash, major road accident, bridge collapse, civil unrest, bush fires, cyclones, earthquakes, severe storms, floods, landslides and or explosions. CSM is registered with Brisbane City Council early warning alert system to ensure early notification.**

On receipt of information from the emergency services about an aircraft or helicopter crash, major road accident, bridge collapse and /or civil unrest the Chief Warden or delegate will ensure that the following information is recorded:

- The caller and his/her telephone number and the time of the call
- The type of emergency
- The location of the emergency
- The number of injured persons
- The type of injuries
- The estimated time of arrival of the injured persons at the Multi-Service Centre
- Create a casualty area
- Prepare for labelling of casualties received
- Restrict entry of unauthorized persons
- Make provision for facilities for relatives of casualties

**For any external emergency Alert Community Services Manager/Case Manager/Care Coordinator and Director of Community Services of the Emergency.**

**Complete an Incident Report immediately after the incident. For all clients, Director of Community Services or CEO to determine if a reportable incident and will contact the Department.**

For all clients, Director of Community Services or CEO to determine if a reportable incident and will contact the Department.

**Call 0 (if applicable) then 000 request an Ambulance**

## Cyclones/Severe Storms

Severe storms or thunderstorms, as classified by the Bureau of Meteorology, are storms that are likely to produce large hail, wind speeds of more than 90km an hour and heavy rainfall conducive to flash flooding. Storms or thunderstorms can be unpredictable and can occur with little warning.



### What can you do to prepare for severe storm season?

- A severe storm warning will only be issued by the Bureau of Meteorology (BOM) for storms that are likely to produce all three elements. BOM alerts can be accessed through the following channels:

Queensland weather warnings: <http://www.bom.gov.au/qld/warnings/>

App for iPhone: <https://apps.apple.com/au/app/bom-weather/id1100096880>

App for Android: <https://play.google.com/store/apps/details?id=au.gov.bom.metview>

- Listen to a local radio station for severe storm advice and warnings;
- Prepare an emergency kit (*emergency phone numbers, portable radio, torch, spare batteries, first aid kit, valuables, and plastic sheets, timber, hammers and nails for temporary repairs*).

### What can you do when a severe storm approaches?

- Shelter and secure animals;
- Put loose garden furniture, equipment etc. inside;
- Park vehicles under solid shelter or cover with firmly tied tarpaulins/blankets;
- Secure all external doors and windows and draw curtains;
- Keep valuables, medications, spare clothing in plastic bags and your emergency kit handy;
- Disconnect all electrical items, external TV/radio aerials and computer modems.

### What can you do when a severe storm strikes?

- Listen to your (portable) radio for severe storm updates;
- Stay inside and shelter and keep well clear of windows, doors and skylights;
- If the building starts to break up, shelter in the strongest part (cellar, internal room, hallway or built-in wardrobe) under a mattress, doona or a strong table or bench;
- If outdoors, seek solid enclosed shelter;
- If driving, stop clear of trees, power lines and streams;
- Don't use a fixed telephone during a severe storm due to lightning danger.

### What can you do after a severe storm has hit?

- Listen to your local radio station for official Advices and Warnings;
- Check for structural property damage and cover with plastic sheeting and nailed on wood strips;



- For emergency assistance refer to your emergency phone numbers or contact your local Council;
- Beware of fallen powerlines and trees, damaged buildings and flooded watercourses; and

### **In case of the evacuation of AQ Multiservice Centre**

Follow the instructions outlined in Evacuation **CODE ORANGE**.

If it is safe to do so:

- Raise your furniture, clothing and valuables onto beds, tables and the roof space (place electrical items as high as possible).
- Empty and turn off refrigerators and freezers, leaving the doors open to help prevent them floating about.
- Turn off the power, water and gas and remember to take your mobile phone.
- Whether you leave or stay, put sandbags in toilet bowls and over all laundry/bathroom drain-holes to prevent sewage back-flow.
- Lock the building and take the recommended evacuation routes for your area.

### **Flood**

What can you do when you hear a flood warning?



- Listen to your local radio station for severe storm advice and warnings;
- Check Bureau of Meteorology Queensland Flood Warning Centre: <http://www.bom.gov.au/hydro/flood/qld/>  
Check your emergency kit.

### Evacuation of AQ Multiservice Centre

Follow the instructions outlined in Evacuation **CODE ORANGE**.

If it is safe to do so:

- Raise your furniture, clothing and valuables onto beds, tables and the roof space (place electrical items as high as possible).
- Empty and turn off refrigerators and freezers, leaving the doors open to help prevent them floating about.
- Plan to move vehicles, outdoor equipment, garbage, chemicals and poisons to higher locations;
- Turn off the power, water and gas and remember to take your mobile phone.
- Whether you leave or stay, put sandbags in toilet bowls and over all laundry/bathroom drain-holes to prevent sewage back-flow.
- Lock the building and take the recommended evacuation routes for your area.

What do you do if you stay or on your return?

- Listen to your local radio station for official Advices and Warnings;

- Avoid entering floodwaters. If you must, wear solid shoes and check depth and current with a stick;
- Stay away from drains, culverts and water over knee-deep;
- Don't use gas or electrical appliances which have been in flood water until checked for safety;
- Don't eat food which has been in flood waters; and
- Boil tap water until supplies have been declared safe.

### **Bushfires**

Bushfire season begins in July and runs through until October but can also extend through to February. However, bushfires can also occur any time.

#### **What can you do in preparation for a bushfire?**

##### 1. Prepare for a bushfire season by:

- Clearing gutters and roofs of leaves, twigs, bark and other debris
- Enclosing open areas under decks and floors
- Checking and maintaining firefighting pumps, generators and water systems
- Removing flammable items away from the house (dry grass and leaves, branches, woodpiles, mulch, boxes, hanging baskets, outdoor furniture)
- Mowing the lawn regularly
- Reducing vegetation along access paths
- Noting your Neighbourhood Safer Place (NSP), if applicable. NSP is a local open space or building where people may gather as a last resort to seek shelter from a bushfire. [Info Sheet - Neighbourhood Safer Places \(qfes.qld.gov.au\)](https://www.qfes.qld.gov.au/info-sheet-neighbourhood-safer-places)
- Have an emergency kit ready: For assistance on preparing check [Will You Stay? | Queensland Fire and Emergency Services \(qfes.qld.gov.au\)](https://www.qfes.qld.gov.au/will-you-stay) or refer to Emergency Kit Contents Form RES 069.

##### 2. Understand your risks:

- Monitor current bushfire warnings and incidents here: [Current bushfire warnings and incidents | Queensland Fire and Emergency Services \(qfes.qld.gov.au\)](https://www.qfes.qld.gov.au/current-bushfire-warnings-and-incident)
- Monitor Fire Bans and Restrictions in the area: [Fire Bans & Restrictions | Queensland Fire and Emergency Services \(qfes.qld.gov.au\)](https://www.qfes.qld.gov.au/fire-bans-and-restrictions)
- Understand your fire danger ratings:

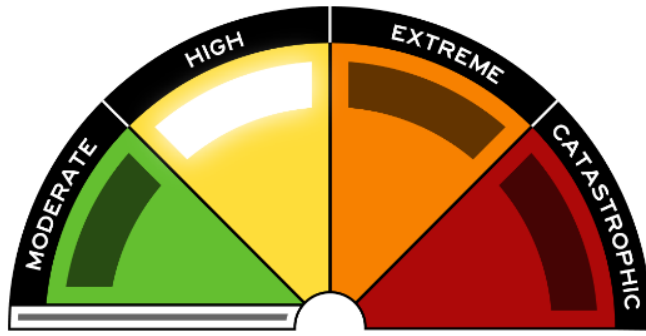

**Moderate: Plan and prepare**

- Stay up to date and be ready to act if there is a fire

**High: Be Ready to Act**

- Decide what you will do if a fire starts
- There is a heightened risk – be alert for fires in your area
- If a fire starts, your life and property may be at risk
- Safest option is to avoid bushfire risk areas

**Extreme: Take Action Now to protect your life and property**

- There are dangerous fire conditions
- Check your bushfire plan and make property is fire ready
- If a fire starts, take immediate action
- If you and/or property is not prepared, go to a safer location well before the fire impacts
- Reconsider travel through bushfire risk areas

**Catastrophic: For your survival, leave bushfire risk areas**

- These are the most dangerous conditions of fire
- Your life may depend on the decisions you make, even before there is a fire
- For survival, do not be in bushfire risk areas
- Stay safe by going to a safer location
- If a fire start and takes hold, lives and properties are likely to be lost
- Homes cannot withstand fires in these conditions – you may not be able to leave and help may not be available.

**Landslide**

### What you should do?

In steep areas, look for the tell-tale signs of ground movement such as trees tilting (down-slope), water seepage and breaks in the ground.



If indoors when a landslide begins, shelter at the least-affected end of the building under a strong table or bench (if possible, use a mattress for extra protection). Hold on firmly and stay put until all land movement has ceased.

If outdoors when a landslide begins, always take heed of warning signs, and avoid the tops and bases of cliffs and embankments, especially where there are signs of loose rocks or debris. Never stand or sit on rock overhangs unless you are sure they can bear your weight.

If a landslide threatens, move quickly from its path and keep clear of banks, trees, powerlines and poles.

### Earthquakes

#### What you should do?

- Find out how and where to turn off power, gas and water supplies.
- Know your safe areas during an earthquake.



#### Watch for possible warning signs

- **Erratic animal behaviours** - scared or confused pets or birdcalls not usually heard at night may indicate that an earthquake is imminent.
- **Ground water levels** - Watch for sudden water level changes in wells or artesian bores.

#### When an earthquake hits

- If you are indoors - stay there (clear of falling debris outside). Keep clear of windows, chimneys and overhead fittings. Shelter under and hold onto a door frame, strong table or bench.
- In high rise buildings, stay clear of windows and outer walls. Shelter under a desk near a pillar or internal wall.
- **DO NOT** use elevators.
- In crowded areas, do not rush for doors, but move clear of overhead fittings and shelves.
- If outside, keep well clear of buildings, overhead structures, walls, bridges, powerlines, trees etc.
- In a city street, shelter from falling debris under strong archways or doorways of buildings. Don't go under awnings as they may collapse.
- In a vehicle, stop in an open area until shaking stops.
- Beware of downed powerlines and road damage, including overpasses and bridges. Listen to your car radio for warnings before moving.

#### After an earthquake

- Turn off electricity, gas, water and **DO NOT** light matches until after you have checked for gas or fuel leaks.

- Check for injuries and apply first aid. **DO NOT** move seriously injured people unless they are in immediate danger.
- Check for broken water, sewerage or electrical mains.
- **DO NOT** use the telephone immediately (to avoid congestion) unless there is a life threatening situation.
- Check for cracks and damage to the roof, chimney etc.
- Evacuate the building if it is badly damaged and be prepared for aftershocks.
- Do not waste food and water as supplies may be interrupted – Collect emergency water from heaters, ice cubes, toilet tanks and canned foods.
- Listen to your local radio station and heed warnings and advice on damage and service disruptions.
- Try to avoid driving unless for an emergency (to keep the streets free for emergency services).
- Try to stay calm and help others if possible.

## **Heatwave**

### Who is vulnerable to the effects of a heatwave?

Although **everyone is vulnerable** to the effects of a heatwave, those most at risk are including



- **Seniors and older** people living alone;
- Pregnant women, breast feeding mothers and infants;
- People taking medications that may interfere with the body's ability to regulate temperature,
- Anyone with:
  - a chronic or mental illness;
  - limited or poor mobility
  - health conditions that may impair sweating;
  - excess body weight (overweight).

Heat related illness can be caused through a combination of **job factors**; such as:

- The level of your exertion and inadequate rest periods;
- Environmental factors such as humidity and radiant heat; and
- Worker factors such as **hydration** and inappropriate clothing.

Heat related illness occurs when body temperature increases through absorbing more heat than can be dispelled. This may develop slowly over a day or two of very hot weather. Prompt action can avoid the serious, or even fatal, consequences of fully developed heat stroke.

- In a severe heatwave you may get dehydrated and your body may overheat, leading to a heat related illness.
- A heat related illness can result in irreversible damage to your body, including the brain, or even death.
- A heat related illness can develop if heat exhaustion is left untreated, but it can also occur suddenly and without warning.

## Ways you can prepare for a heatwave

Listen to your **local weather forecast** so you know if a heatwave is approaching.

- Plan ahead to reduce the risk of getting **heat exhaustion** or a heat related illness by staying inside or minimise time out in the heat;
- Look at alternatives to help to cool the building (e.g. awnings, shade cloth or internal blinds or curtains on the sides of the building which face the sun);
- Check that cooling systems in clients' homes are adequate and working effectively;
- Assess clients at risk (who has limited capacity to keep cool or which homes or are prone to being hot);
- Offer extra support to clients where family and friends are not available to help;
- Provide contact details of your clients to location emergency services where appropriate; and
- Prepare for a power failure:
  - Plan for what you would do if a heatwave caused failure of electricity supply;
  - If a power failure does occur, ensure you have a torch, fully-charged telephone or mobile phone, battery operated radio and spare batteries.

## During a heatwave

- Continue to deliver care - source additional staff if required;
- Be aware of client may be at particular risk following high overnight temperatures;
- Keep curtain and blinds closed in clients' homes to reduce excess heat;
- Make small amounts of fluids readily available for clients;
- Provide alternative forms of fluid and discourage alcoholic or caffeinated beverages;
- Encourage clients to eat frequent small meals;
- Encourage clients to wear loose fitting clothing, use sunscreen and keep skin covered when exposed to direct sunlight;
- Encourage clients to seek shade when outside, and to avoid going out between 11am and 3pm;
- Offer additional tepid showers or sponging;
- Look for signs of heat stress (e.g. nausea, changing in appearing including red, pale or severely dry skin; and
- Ask for a clinical assessment if care recipients how any signs of deterioration.

## Civil Disorders

During Civil disturbances such as **protests, blockades and forced entry** to buildings minimize contact of those causing disturbance with residents.

On receipt of information from the emergency services about a **civil unrest** the Chief Warden or delegate will ensure that the following information is recorded:



- The caller and his/her telephone number and the time of the call
- The type of emergency
- The location of the emergency

In addition the following steps shall be taken:

- Notify Community Service Manager/Case Manager/Care Coordinator of the External Emergency
- Establish an Emergency Control Organisation at your control point
- Verify the authenticity of the information from the appropriate emergency service
- Chief warden to announce **CODE BROWN** to wardens
- Restrict entry of unauthorized persons
- Provide information to the QPS for release to relatives and media.

Initiate security lockdown action:

- Restrict contact between the demonstrators and the residents or staff (move residents to safe areas within the building);
- Restrict entrance to the site (do not obstruct emergency exits)
- Restrict /confine presence within the site if entry has occurred
- Ensure cash, critical records, equipment and valuable items are secure
- Remove any objects in accessible locations which could be used as weapons or missiles by aggressive trespassers.

On instruction from the Chief Warden the Area Warden will **during an emergency involving civil unrest:**

- Carry out the instructions of the Chief Warden.
- Restrict entry of unauthorized persons.
- Do not make statements to the media.
- Invoke AAQ-P-15 Procedure. Media contact will be coordinated by the Chief Executive Officer of the Association. Requests for interviews or comment by the media will be referred to the Chief Executive Officer. Staff are not authorized to offer a comment to a member of the media.
- List information for the Chief Warden to release to QPS.

For all medical/first aid related incidents or emergencies, in the event of a suspected cardiac arrest or the need for urgent medical assistance.

**Note: “Patient” refers to client, staff member or visitor**

**DRSABCD Action Plan:**

**D**

**DANGER**

Use all senses to check for dangers to yourself, others and the patient. Ensure the area is safe. Move the patient only if the danger cannot be eliminated.



**R**

**RESPONSE**

Check for a normal response by talking to the patient, asking them their name and squeezing their shoulders  
**DO NOT** move the patient if the injury is the result of a fall



**S**

**SEND FOR HELP**

Send a bystander to call for help and an Ambulance as soon as possible  
**DIAL 000** and ask for Ambulance attendance.



**A**

**AIRWAY**

Open mouth and check for foreign objects. If objects are present place in recovery position and clear airway with fingers.  
**DO NOT** move patient if the injury is the result of a fall.



**B**

**BREATHING**

Check breathing. **Look** for rise and fall of chest. **Listen** for breathing sounds. **Feel** for breaths on the cheek and for ribcage movement. If breathing is present keep the patient in the recovery position and monitor.



**C**

**CPR**

If no breathing is present commence CPR.  
Give **30 Chest Compressions to every 2 Breaths**  
@ 100 Compressions/minute.



**D**

**DEFIBRILLATION**

Apply defibrillator (if available) and follow the voice prompts or instruction on the device.  
AED - Automated External Defibrillator



**Continue CPR until responsiveness or normal breathing returns**



Note:

- Never leave the patient alone.
- Do not move the patient unless you are exposed to a life-threatening situation.
- Provide support and appropriate assistance until emergency help arrives.

**Alert Community Service Manager/Case Manager/Care Coordinator & Director of Community Services of Emergency.**

**Complete an Incident Report immediately after the incident.**

For all clients, Director of Community Services or CEO to determine if a reportable incident and will contact the Department.

## 15.8 MISSING PERSON

On discovery of a missing client all staff are to search immediate vicinity and surrounding areas on foot and via vehicles. Making sure that safety of all remaining clients is not put at risk. Take centre mobile phones with you.

<p><b>Within 10 minutes</b> of the incident occurring</p>	<p>Staff are to notify the Community Service Manager (CSM) /Case Manager/Care Coordinator of where, when, how or why client went missing. Keep a log of the incident details and the actions taken.</p>
<p><b>Within 30 minutes</b> of the incident occurring</p>	<p>The CSM is to;</p> <ul style="list-style-type: none"> <li>• Notify Home Care Manager and/or Director of Community Services and Carer of the Incident. The CSM to keep in contact with family on an hourly basis, until client found.</li> <li>• Notify the Queensland Police Service (QPS) of the incident and provide description of client, what they were wearing and provide a photograph of the client.</li> <li>• Alert taxi companies, council and private bus companies, local train stations, local hospitals and ambulance and fax a photograph of client to these organisations.</li> <li>• Request advice from the QPS on the extent of client details that needs to be released and request a police reference number.</li> <li>• Provide to the Search Party which consists of AQ staff and clients' relatives or volunteers with a description of client, what they were wearing and provide a photograph of the client.</li> </ul>
<p><b>Within 1 hour</b> of the incident occurring</p>	<p>The Director of Community Services is to notify the Chief Executive Officer and the Director of Human Resources of the incident.</p> <ul style="list-style-type: none"> <li>• If client is <b>not found in 1 hour</b> of the incident occurring the CSM requests the Queensland Police Service (QPS) to place the description of the client on the QPS Facebook. Director of Human Resources to initiate radio announcements about missing client.</li> </ul>
<p><b>Within 12 hours</b> of the incident occurring</p>	<p>The CSM or staff member is to commence / complete an incident report and update client file notes.</p>
<p><b>Within 24 hours</b> of the incident occurring</p>	<p>This incident is a Priority 1 under the SIRS reporting scheme. The CSM or delegate is required to enter the incident into Riskman and populate the draft into the My Aged Care portal. The State Director is to be notified once the SIRS incident has been populated as a draft in MAC and will advise CEO. Prior to the SIRS incident being logged in SIRS as final, enter this request the Quality Manager and State Director approval.</p>
<p><b>Within 48 hours</b> of the incident occurring</p>	<p>The CSM to debrief the staff and implement preventative action. Also a meeting is arranged with the CEO, Director of Community Services, Director of Human Resources and the QM to review the incident and the missing person procedure.</p>

## When Client is found

- Step 1:** Check client for injuries render first aid (if required) and or arrange for medical examination.
- Step 2:** Staff to Notify
- Community Service Manager
  - Carer
  - Director of Community Services
  - Chief Executive Officer
  - Director of Human Resources
  - QPS and Search Party if applicable
- Step 3:** Provide **emotional support** to client and relatives (if required)
- Step 4:** Liaise with police to confirm identity, if not AAQ staff that have located client. CSM or closest staff member to head to the location of client and support client until family arrives.
- Step 5:** Organise **client's GP to examine consumer ASAP** or transfer client to hospital for examination (if required)
- Step 6:** Meet with staff involved in client going missing. Identify gaps and develop recommendations to prevent happening in future.

## MISSING PERSON FLOWCHART

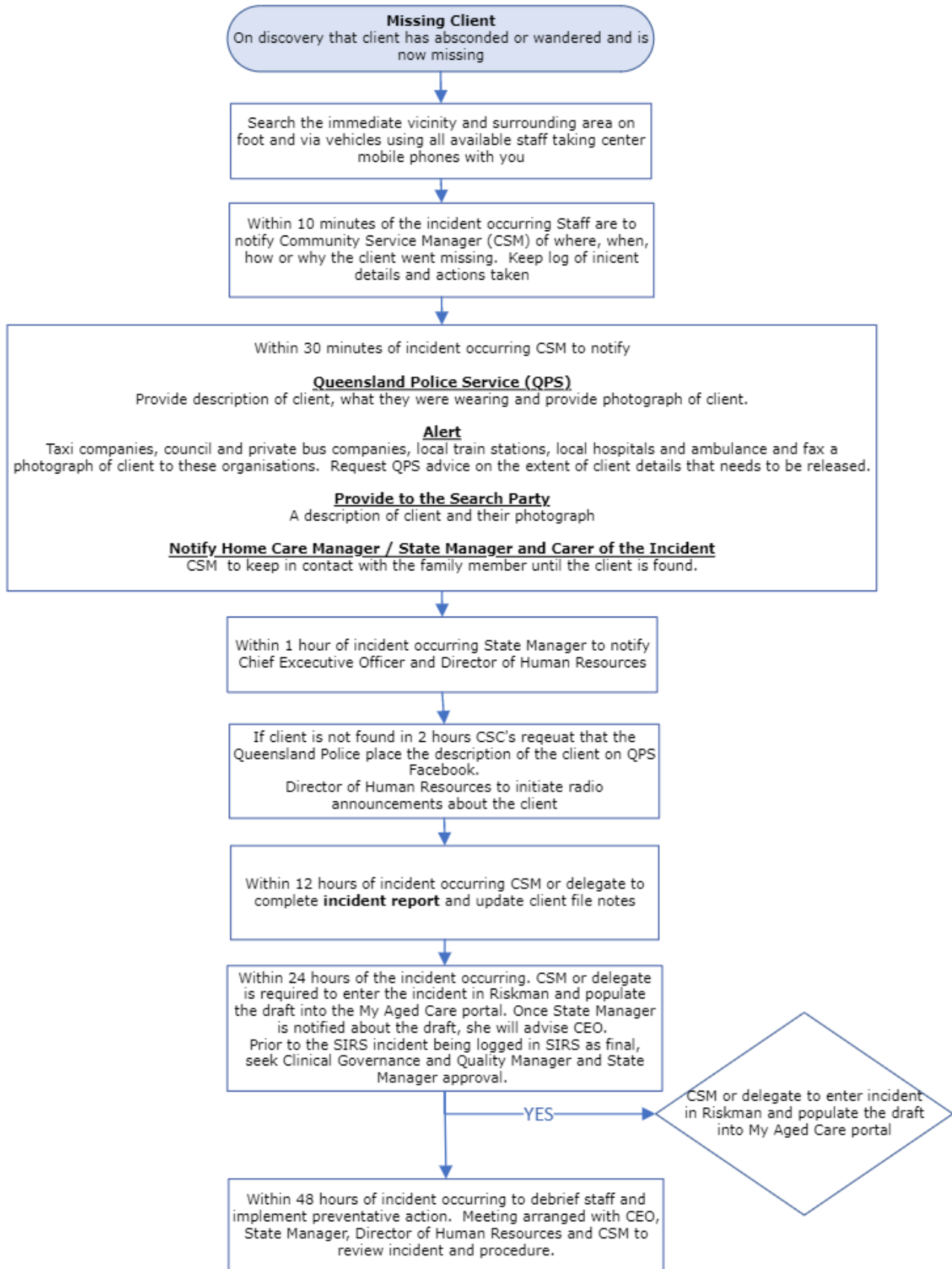

## 16.0 REFERENCES

AS 3745 - 2010 Planning for Emergencies in Facilities

AS 4083 - 2010 Planning for Emergencies – Health Care Facilities

Queensland- Building Fire Safety Regulation 2008

Queensland Disaster Management Act 2003

Disaster Management Act 2003

Disaster Management Queensland - <https://www.disaster.qld.gov.au/Pages/default.aspx>

Brisbane City Council Local Disaster Management Plan

<https://www.brisbane.qld.gov.au/sites/default/files/documents/2023-06/20230608-2022-local-disaster-management-plan.pdf>

Queensland Government Brisbane District Disaster Management Plan 2022-2023

<https://www.police.qld.gov.au/sites/default/files/2023-01/BrisbaneDDMP.pdf>

Emergency Action Plan St John Ambulance Australia

Australian Government Dept of Health – Ageing & Aged Care

Reportable Assault & Unexplained Absence Report Form–

<https://agedcare.health.gov.au/ensuring-quality/aged-care-quality-and-compliance/compulsory-reporting-for-approved-providers>

Australian Government – Aged Care Quality and Safety Commission

Commonwealth Home Support Programme Manual

<https://www.health.gov.au/resources/publications/commonwealth-home-support-programme-chsp-manual?language=en>

Caring for older people in warmer weather – Home Care and CHSP

<https://www.health.gov.au/resources/publications/caring-for-older-people-in-warmer-weather-home-care-and-chsp?language=en>

## 17.0 ASSOCIATED PROCEDURES AND FORMS

AAQ-F-019 Incident Reporting Form

RES-F-069 Emergency Kit Contents

AAQ-P-15 Media and Publications

HCP-F-068 Hazard and Risk Reporting Form

HCP-F-032 Home Safety Checklist – In Home Services

COM-F-050 Vulnerability Assessment

AAQ-P-038.2 Incident Management – Community Services

AAQ-P-01 Workplace Health and Safety

## 18.0 APPENDIX A – EMERGENCY CONTROL ORGANISATION REGISTER

Document controlled on the AQ intranet by Quality Coordinator

<b>Date Amended</b>	<b>Amendment No.</b>	<b>Amended by</b>	<b>Signature</b>	<b>Location</b>
25/08/2016	2	Imogen Patterson		AAQ Intranet
09/05/2018	3	Celeste Murray		AAQ Intranet
05/07/2019	4	Samanthar McGuffin		AAQ Intranet
01/07/2020	5	Samanthar McGuffin		AAQ Intranet
10/02/2021	6	Raeleigh Farley		AAQ Intranet
06/05/2021	7	Raeleigh Farley		AAQ Intranet
16/11/2021	8	Raeleigh Farley		AAQ Intranet
16/11/2022	9	Raeleigh Farley		AAQ Intranet
20/12/2023	10	Raeleigh Farley		AAQ Intranet

19.0 APPENDIX B EMERGENCY EVACUATION PLANS

# EVACUATION SIGN & DIAGRAM



83 CHERMSIDE ROAD  
EAST IPSWICH, QLD  
FIRST FLOOR

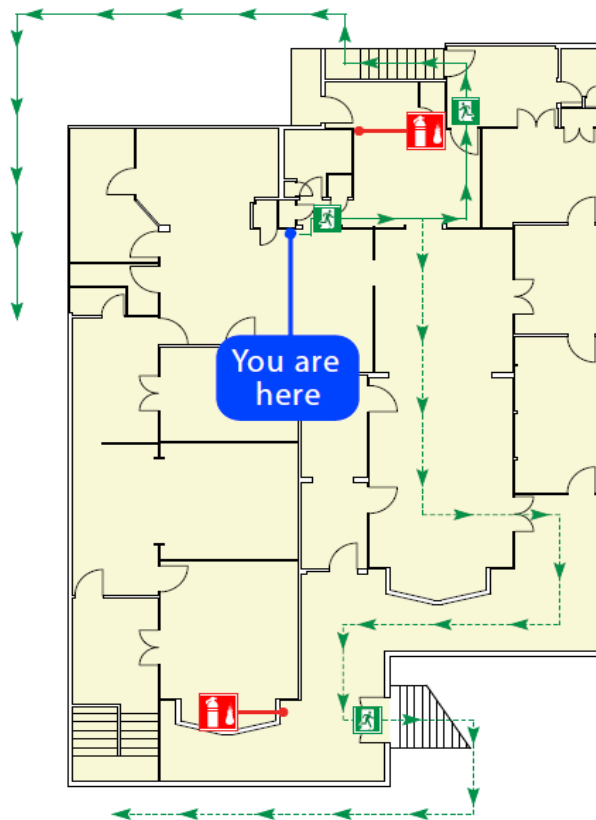

**IN AN EMERGENCY CALL**

**000**



Mobility impaired persons should evacuate immediately on hearing the fire alarm assisted by a nominated person.

**EMERGENCY PROCEDURES**

**REMOVE PEOPLE FROM IMMEDIATE DANGER**

- If an emergency incident occurs, move a safe distance away from the danger.
- Prevent others from entering the area and alert surrounding people.
- If safe and trained to do so, attempt to extinguish the fire / contain the emergency incident.
- Continually assess the situation and do not put yourself or others at risk.

**NOTIFY EMERGENCY SERVICES**

- Dial 000

**EVACUATE THE BUILDING**

- In the event of the smoke, fire or emergency incident worsening, EVACUATE immediately via the nearest safe exit.
- When the area has been evacuated all doors and windows should be closed to contain the fire. Do not obstruct access to exits.

**PROCEED TO YOUR ASSEMBLY AREA**

- Refer to the Site Plan and await instructions from the Emergency Services.

**EXTINGUISHER OPERATION**



**SITE PLAN**

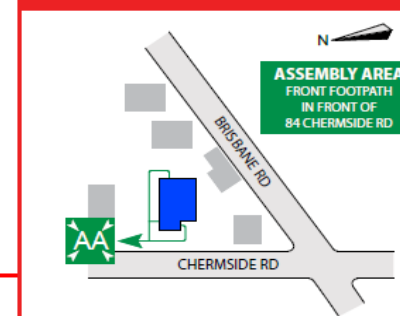

- DRY CHEMICAL EXTINGUISHER
- FIRE BLANKET
- FIRST AID
- PATH OF EXIT
- ALTERNATIVE PATH OF EXIT
- EXIT
- ASSEMBLY AREA

**SAFETY CONSIDERATIONS - R** REMOVE PEOPLE from immediate danger    **A** ALERT THE FIRE SERVICE - call 000    **C** ONFINE FIRE & SMOKE - close doors and windows (if safe)    **E** VACUATE to the Assembly Area

Produced by Fire Safety Compliance Services Pty Ltd

Effective from: July 2019

# EVACUATION SIGN & DIAGRAM



83 CHERMSIDE ROAD  
EAST IPSWICH, QLD  
FIRST FLOOR

IN AN EMERGENCY CALL

**000**



Mobility impaired persons should evacuate immediately on hearing the fire alarm assisted by a nominated person.

## EMERGENCY PROCEDURES

### REMOVE PEOPLE FROM IMMEDIATE DANGER

- If an emergency incident occurs, move a safe distance away from the danger.
- Prevent others from entering the area and alert surrounding people.
- If safe and trained to do so, attempt to extinguish the fire / contain the emergency incident.
- Continually assess the situation and do not put yourself or others at risk.

### NOTIFY EMERGENCY SERVICES

- Dial 000

### EVACUATE THE BUILDING

- In the event of the smoke, fire or emergency incident worsening, EVACUATE immediately via the nearest safe exit.
- When the area has been evacuated all doors and windows should be closed to contain the fire. Do not obstruct access to exits.

### PROCEED TO YOUR ASSEMBLY AREA

- Refer to the Site Plan and await instructions from the Emergency Services.

## EXTINGUISHER OPERATION

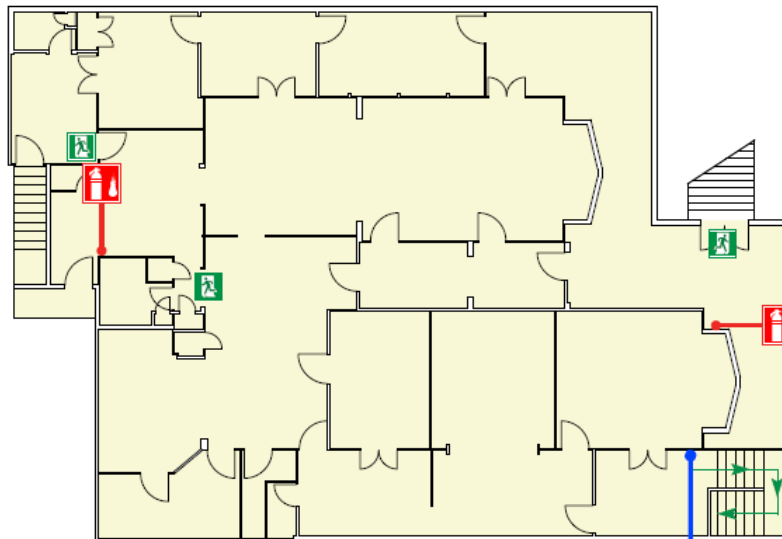

You are here



**S**AFETY CONSIDERATIONS - **R**EMOVE PEOPLE from immediate danger **A**LERT THE FIRE SERVICE - call 000 **C**ONFINED FIRE & SMOKE - close doors and windows (if safe) **E**VACUATE to the Assembly Area

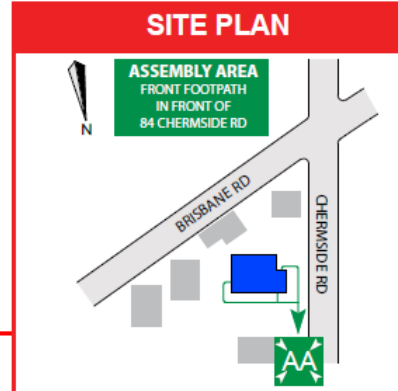

Effective from: July 2019



# EVACUATION SIGN & DIAGRAM



83 CHERMSIDE ROAD  
EAST IPSWICH, QLD  
FIRST FLOOR

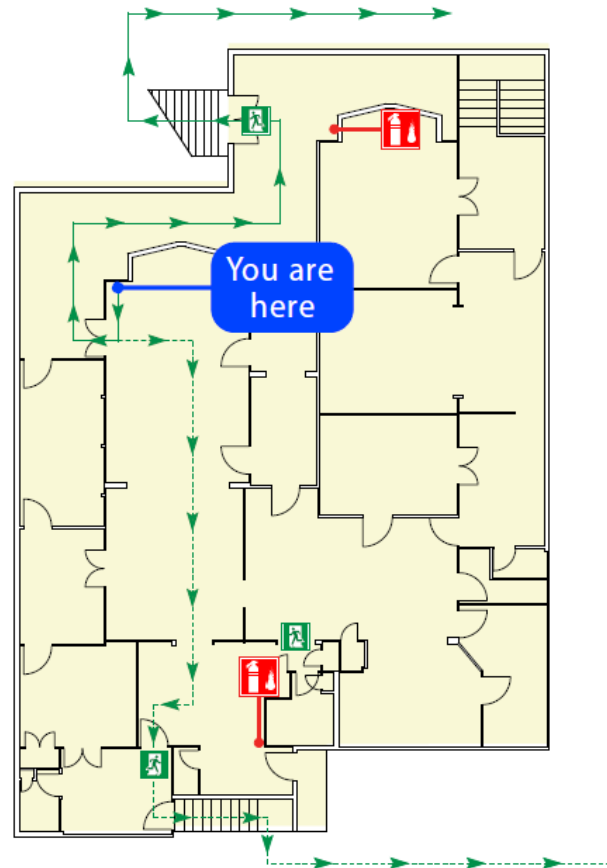

IN AN EMERGENCY CALL

**000**



Mobility impaired persons should evacuate immediately on hearing the fire alarm assisted by a nominated person.

## EMERGENCY PROCEDURES

### REMOVE PEOPLE FROM IMMEDIATE DANGER

- If an emergency incident occurs, move a safe distance away from the danger.
- Prevent others from entering the area and alert surrounding people.
- If safe and trained to do so, attempt to extinguish the fire / contain the emergency incident.
- Continually assess the situation and do not put yourself or others at risk.

### NOTIFY EMERGENCY SERVICES

- Dial 000

### EVACUATE THE BUILDING

- In the event of the smoke, fire or emergency incident worsening, EVACUATE immediately via the nearest safe exit.
- When the area has been evacuated all doors and windows should be closed to contain the fire. Do not obstruct access to exits.

### PROCEED TO YOUR ASSEMBLY AREA

- Refer to the Site Plan and await instructions from the Emergency Services.

## EXTINGUISHER OPERATION

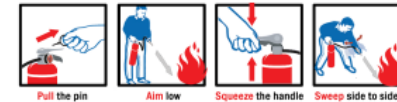

## SITE PLAN

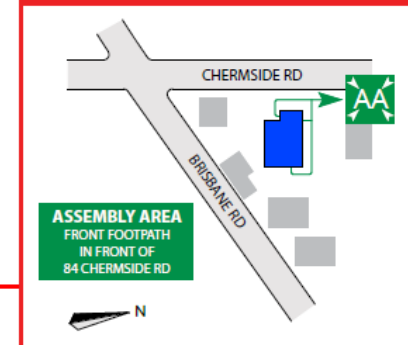

**SAFETY CONSIDERATIONS - R** REMOVE PEOPLE from immediate danger    **A** ALERT THE FIRE SERVICE - call 000    **C** ONFINE FIRE & SMOKE - close doors and windows (if safe)    **E** VACUATE to the Assembly Area

Produced by Fire Safety Compliance Services Pty Ltd

Effective from: July 2019

# EVACUATION SIGN & DIAGRAM



83 CHERMSIDE ROAD  
EAST IPSWICH, QLD  
GROUND FLOOR

IN AN EMERGENCY CALL

**000**



Mobility impaired persons should evacuate immediately on hearing the fire alarm assisted by a nominated person.

## EMERGENCY PROCEDURES

### REMOVE PEOPLE FROM IMMEDIATE DANGER

- If an emergency incident occurs, move a safe distance away from the danger.
- Prevent others from entering the area and alert surrounding people.
- If safe and trained to do so, attempt to extinguish the fire / contain the emergency incident.
- Continually assess the situation and do not put yourself or others at risk.

### NOTIFY EMERGENCY SERVICES

- Dial 000

### EVACUATE THE BUILDING

- In the event of the smoke, fire or emergency incident worsening, EVACUATE immediately via the nearest safe exit.
- When the area has been evacuated all doors and windows should be closed to contain the fire. Do not obstruct access to exits.

### PROCEED TO YOUR ASSEMBLY AREA

- Refer to the Site Plan and await instructions from the Emergency Services.

## EXTINGUISHER OPERATION

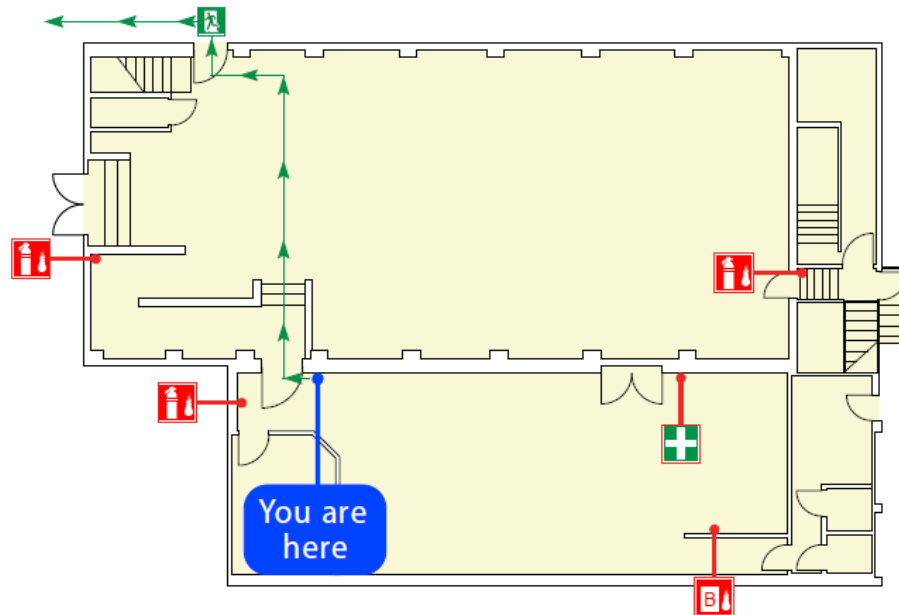

## SITE PLAN

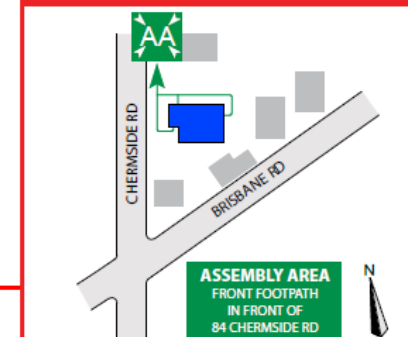

**S**AFETY CONSIDERATIONS - **R**EMOVE PEOPLE from immediate danger **A**LERT THE FIRE SERVICE - call 000 **C**ONFINED FIRE & SMOKE - close doors and windows (if safe) **E**VACUATE to the Assembly Area

Produced by Fire Safety Compliance Services Pty Ltd

Effective from: July 2019

# EVACUATION SIGN & DIAGRAM



83 CHERMSIDE ROAD  
EAST IPSWICH, QLD  
GROUND FLOOR

**IN AN EMERGENCY CALL**  
**000**

**Mobility impaired persons should evacuate immediately on hearing the fire alarm assisted by a nominated person.**

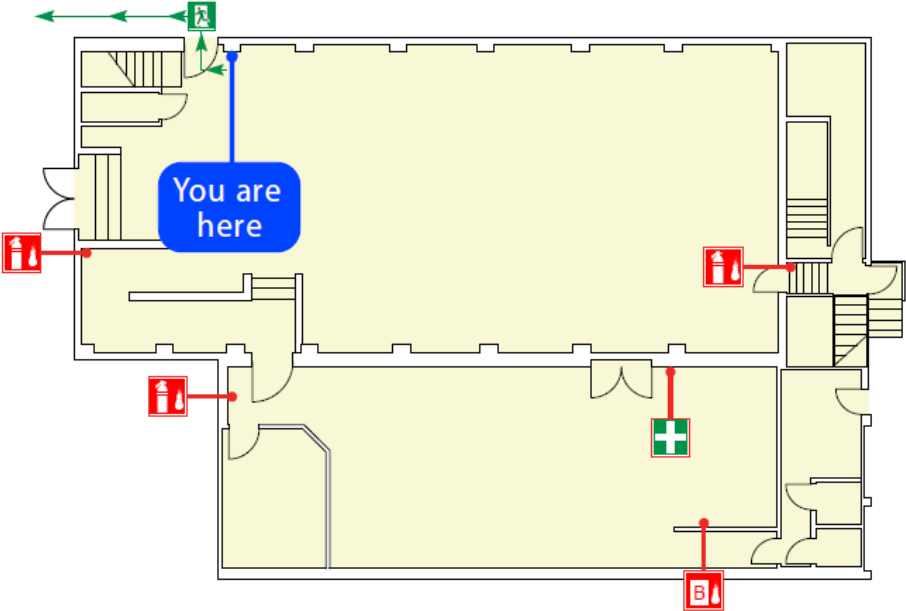

### EMERGENCY PROCEDURES

**REMOVE PEOPLE FROM IMMEDIATE DANGER**  
 • If an emergency incident occurs, move a safe distance away from the danger.  
 • Prevent others from entering the area and alert surrounding people.  
 • If safe and trained to do so, attempt to extinguish the fire / contain the emergency incident.  
 • Continually assess the situation and do not put yourself or others at risk.

**NOTIFY EMERGENCY SERVICES**  
 • Dial 000

**EVACUATE THE BUILDING**  
 • In the event of the smoke, fire or emergency incident worsening, EVACUATE immediately via the nearest safe exit.  
 • When the area has been evacuated all doors and windows should be closed to contain the fire. Do not obstruct access to exits.

**PROCEED TO YOUR ASSEMBLY AREA**  
 • Refer to the Site Plan and await instructions from the Emergency Services.

### EXTINGUISHER OPERATION



### SITE PLAN

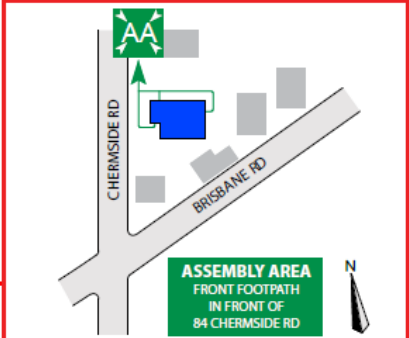

- DRY CHEMICAL EXTINGUISHER
- FIRE BLANKET
- FIRST AID
- PATH OF EXIT
- ALTERNATIVE PATH OF EXIT
- EXIT
- ASSEMBLY AREA

**SAFETY CONSIDERATIONS - R** REMOVE PEOPLE from immediate danger    **A** ALERT THE FIRE SERVICE - call 000    **C** ONFINE FIRE & SMOKE - close doors and windows (if safe)    **E** VACUATE to the Assembly Area

Produced by Fire Safety Compliance Services Pty Ltd Effective from: July 2019

# EMERGENCY EVACUATION

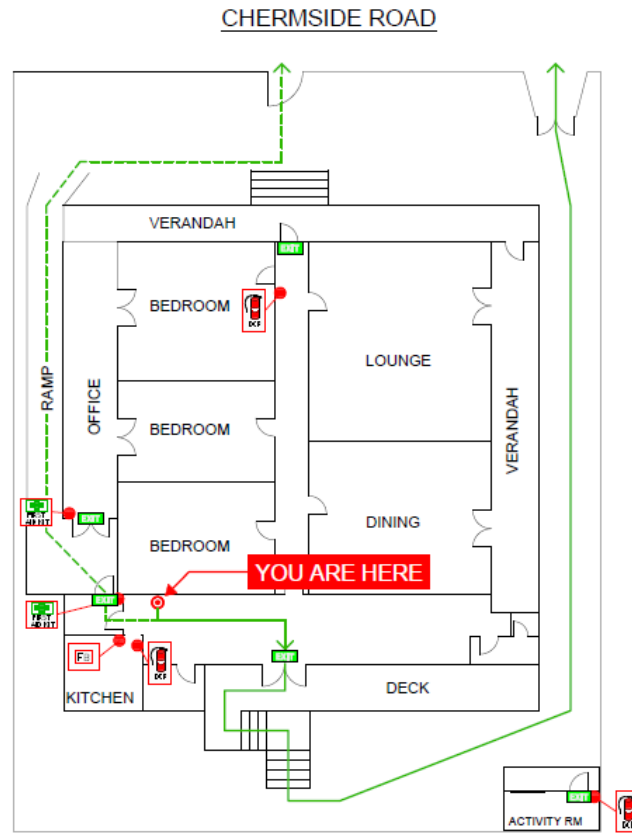

## LEGEND

- |  |                   |  |                |
|--|-------------------|--|----------------|
|  | FIRE EXTINGUISHER |  | ALTERNATE EXIT |
|  | FIRE BLANKET      |  | EXIT ROUTE     |
|  | FIRST AID KIT     |  | EXIT           |



## EMERGENCY PROCEDURES



### IN CASE OF FIRE (Remember RACE..!)

- R** REMOVE PEOPLE FROM IMMEDIATE DANGER AREA  
(Do not obstruct Exits and Exit Routes)
- A** ALERT PEOPLE NEARBY AND RAISE AN ALARM  
(DIAL 000 and ask for the fire brigade)
- C** CONFINE FIRE AND SMOKE  
Close doors behind you and where practicable, windows. (To contain Smoke/Fire).
- E** EVACUATE  
Evacuate the premises!

#### If an EVACUATION is required

- Secure your area and evacuate the building via the nearest safe exit and proceed to your external Assembly Area
- Ensure other occupants are aware of the evacuation and assist them if necessary

#### At the Assembly Area....

- Account for the people on your floor
- Report any person missing to the responding authorities

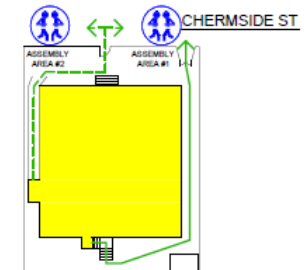

ALZHEIMER'S ASSOCIATION  
84 CHERMSIDE ROAD  
IPSWICH Q 4305



Chubb Training  
11175 Sandstone Road  
Ancherfield QLD 4107  
Australia  
Tel: +61 (0)7 3330 3008  
Fax: +61 (0)7 3330 3000

DATE: 20/12/2023  
DRAWN DATE: 20/12/2023  
DRAWN BY: S.S.  
NOT TO SCALE

# EMERGENCY EVACUATION

## EMERGENCY PROCEDURES



### IN CASE OF FIRE (Remember RACE..!)

- R** REMOVE PEOPLE FROM IMMEDIATE DANGER AREA  
(Do not obstruct Exits and Exit Routes)
- A** ALERT PEOPLE NEARBY AND RAISE AN ALARM  
(DIAL 000 and ask for the fire brigade)
- C** CONFINE FIRE AND SMOKE  
Close doors behind you and where practicable, windows. (To contain Smoke/Fire)
- E** EVACUATE  
Evacuate the premises!

#### If an EVACUATION is required

- Secure your area and evacuate the building via the nearest safe exit and proceed to your external Assembly Area
- Ensure other occupants are aware of the evacuation and assist them if necessary

#### At the Assembly Area....

- Account for the people on your floor
- Report any person missing to the responding authorities

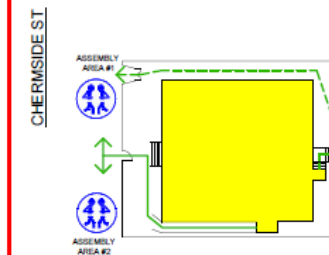
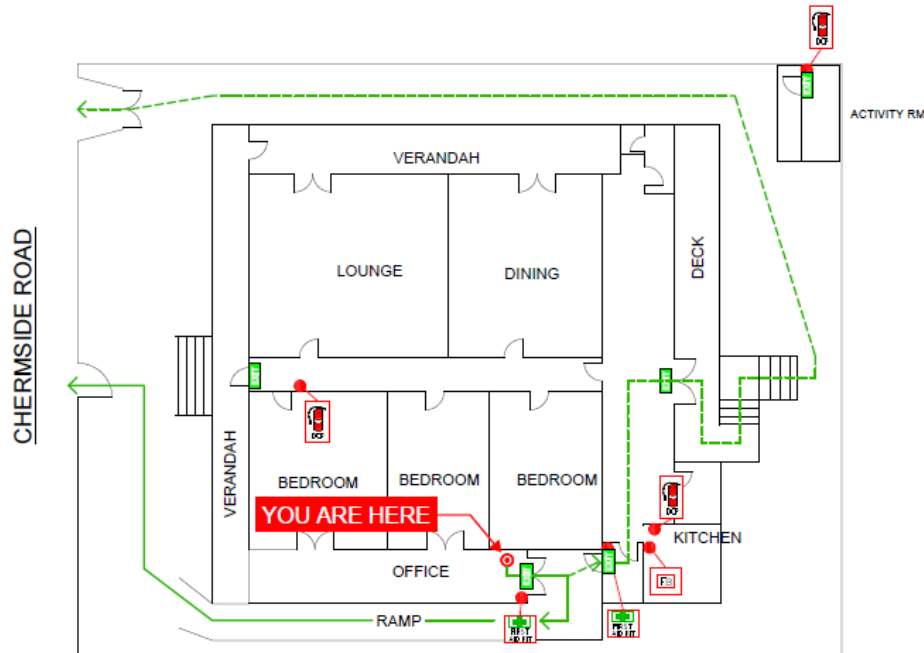

### LEGEND

- |  |                   |  |                |
|--|-------------------|--|----------------|
|  | FIRE EXTINGUISHER |  | ALTERNATE EXIT |
|  | FIRE BLANKET      |  | EXIT ROUTE     |
|  | FIRST AID KIT     |  | EXIT           |



ALZHEIMER'S ASSOCIATION  
84 CHERMSIDE ROAD  
IPSWICH Q 4305



Chubb Fire  
1/1075 Deacon Street  
Austral  
Tel: +61 (0)7 3320 3000  
Fax: +61 (0)7 3320 3000

DATE: 20/12/2023  
DRAWN BY: [Name]  
CHECKED BY: [Name]  
SCALE: 1:100

# EMERGENCY EVACUATION

CHERMSIDE ROAD

## EMERGENCY PROCEDURES

### IN CASE OF FIRE (Remember RACE..!)

**R** REMOVE PEOPLE FROM IMMEDIATE DANGER AREA  
(Do not obstruct Exits and Exit Routes)

**A** ALERT PEOPLE NEARBY AND RAISE AN ALARM  
(DIAL 000 and ask for the fire brigade)

**C** CONFINE FIRE AND SMOKE  
Close doors behind you and where practicable, windows. (To contain Smoke/Fire)

**E** EVACUATE  
Evacuate the premises!

**If an EVACUATION is required**

- Secure your area and evacuate the building via the nearest safe exit and proceed to your external Assembly Area
- Ensure other occupants are aware of the evacuation and assist them if necessary

**At the Assembly Area...**

- Account for the people on your floor
- Report any person missing to the responding authorities

### LEGEND

<ul style="list-style-type: none"> <li> FIRE EXTINGUISHER</li> <li> FIRE BLANKET</li> <li> FIRST AID KIT</li> </ul>	<ul style="list-style-type: none"> <li> ALTERNATE EXIT</li> <li> EXIT ROUTE</li> <li> EXIT</li> </ul>
---	---

**ALZHEIMER'S ASSOCIATION**  
84 CHERMSIDE ROAD  
IPSWICH Q 4305

**Chubb**  
Chubb Training  
11075 Rosemead Road  
Auchenfield QLD 4107  
Australia  
Tel: +61 (0)7 3320 3000  
Fax: +61 (0)7 3320 3000

DATE: 20/12/2023  
DRAWN DATE: 20/12/2023  
DRAWN BY: S.S.

# EVACUATION DIAGRAM

## ALZHEIMER'S QUEENSLAND

85 Chermide Rd, Ipswich, 4305

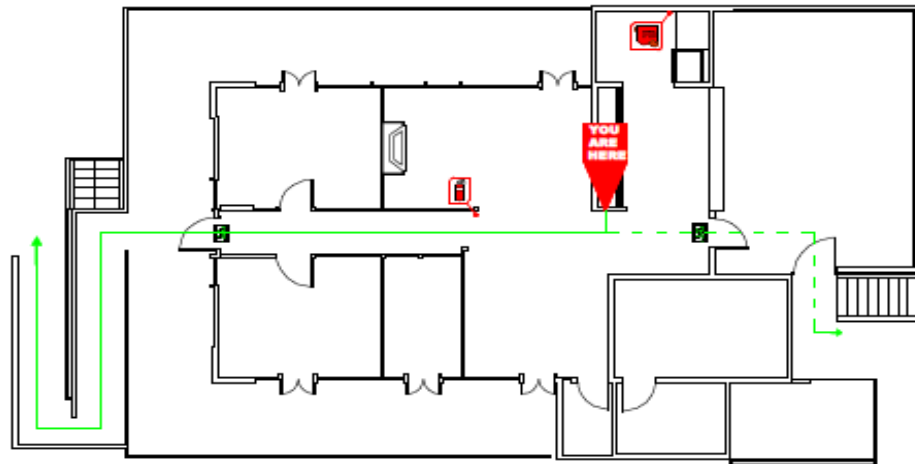

### EVACUATION PROCEDURES

**UPON THE DISCOVERY OF A FIRE OR BECOMING AWARE OF FIRE IN THE BUILDING**

- Raise an alarm by shouting Fire, Fire, Fire!
- Advise Responsible Person or staff member of location of fire
- Commence evacuation of immediate danger using designated fire exits
- Assemble at the designated Assembly Area

### AT THE ASSEMBLY AREA

- Account for people in the building
- Report any person missing to fire brigade and/or the responding authorities

**DO NOT RE-ENTER THE BUILDING UNTIL THE FIRE BRIGADE DECLARES IT SAFE TO DO SO**

#### To operate an extinguisher

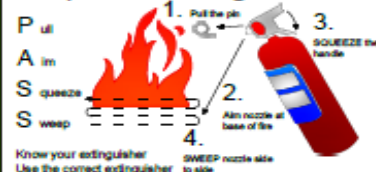

**R** REMOVE PEOPLE FROM IMMEDIATE DANGER  
(Do not obstruct Exits & Exit Routes)

**A** ALERT PEOPLE NEARBY AND RAISE AN ALARM  
(DIAL 000 and ask for fire Brigade)

**C** CONFINE FIRE AND SMOKE  
Close doors and windows behind you if safe to do so

**E** EXTINGUISH the fire if safe to do so  
Alternatively evacuate to ASSEMBLY AREA

#### LEGEND

- DCP Fire Extinguisher
- Fire Blanket
- Primary Exit Path
- Secondary Exit Path
- Exit Sign

